

• Behind the News • Health • UFOs • Future Science •

NEXUS

NEW TIMES • Vol 10, N° 5

AUGUST – SEPTEMBER 2003

AUSTRALIA (incl. GST) \$5.95

NZ (incl. GST) NZD \$5.95

USA USD \$4.95

UK STG £2.80

EU €4.50

Cancer: the shock factor

The perils of pet food

**Hidden secrets of the
Solomon Islands**

**Project Hammer: an elite
banking cabal is exposed**

Etheric Weather Engineering

ISSN 1039-0170



Print Post Approved PP442036/0005

• Rockefeller NWO Agenda • DNA BioHologram •

NEXUS

NEW TIMES MAGAZINE

Volume 10, Number 5 AUGUST – SEPTEMBER 2003

UK/European Edition

CONTENTS

LETTERS TO THE EDITOR.....	4	FROM HELIX TO HOLOGRAM.....	49
GLOBAL NEWS.....	6	<i>By Iona Miller and Richard Alan Miller. Life is fundamentally electromagnetic, and the DNA helix serves as a bioholographic matrix that guides the organisation of physical form.</i>	
<i>Breaking news, including Pentagon surveillance and space weapons plans, research linking solar flares with Earth temperatures, and a complaint to the ICC on pharmaceutical industry crimes.</i>		THE SNAKE DRAGON MYSTERY.....	55
THE PET FOOD INDUSTRY'S PRACTICES.....	11	<i>By Marius Boirayon. The Solomon Islanders have a long history of encounters with strange aerial craft and alien beings, and recent experiences sparked this former RAAF engineer to search for UFO bases.</i>	
<i>By Ann Martin. The pet food industry must be regulated to ensure that only safe ingredients, not the remains of euthanised companion animals, are included in commercial pet foods.</i>		THE TWILIGHT ZONE.....	61
THE NEW MEDICINE OF DR HAMER.....	19	<i>Marius Boirayon reports on eyewitness accounts of Giants that still exist in the caves and mountainous jungles of the Solomon Islands, prompting us to question conventional ideas of evolution.</i>	
<i>By Walter Last. For discovering the shock-conflict mechanism underlying cancer and demonstrating it with CT brain scans, Dr Ryke Geerd Hamer has been persecuted by courts across Europe.</i>		REVIEWS—Books.....	65
ROCKEFELLER INTERNATIONALISM—Part 3.....	27	<i>"Surgery and its Alternatives" by Drs Sandra and David McLanahan</i>	
<i>By Will Banyan. For decades David Rockefeller has been promoting a "one world" vision to fellow powerbrokers, while rejecting criticism that he has any role in a cabal intent on controlling the planet.</i>		<i>"Maya: The World as Virtual Reality" by Richard L. Thompson</i>	
PROJECT HAMMER RELOADED—Part 1.....	33	<i>"What Really Causes AIDS" by Harold D. Foster</i>	
<i>By David Guyatt. Gold bullion and other booty looted during World War II is still being used to fund secret trading programs that bankroll black projects and rescue major banks from insolvency.</i>		<i>"Healing Sounds: The Power of Harmonics" by Jonathan Goldman</i>	
SCIENCE NEWS.....	39	<i>"Firestorm" by Ann Druffel</i>	
<i>From Etheric Rain Engineering Pte Ltd. Expanding on Dr Wilhelm Reich's Cloudbuster technology, Trevor J. Constable has proved that etheric energy devices can dissipate smog and break drought.</i>		<i>"The Masters of the Mystical Rose" by Maree Moore</i>	
LEE CROCK'S 'AURA THERAPY' MACHINE.....	43	<i>"The H.I.S.S. of the A.S.P." by David Ritchey</i>	
<i>By Jerry Decker. A simple electronic device connected to a wire mesh screen with a polarity switch mechanism can act on the body's auric field to assist healing at the cellular level.</i>		<i>"Secret Societies of America's Elite" by Steven Sora</i>	
		<i>"America's Secret Establishment" by Antony C. Sutton</i>	
		<i>"Pyramid of Secrets" by Alan Alford</i>	
		<i>"The Age of Consent" by George Monbiot</i>	
		<i>"Earth Rising II" by Dr Nick Begich and James Roderick</i>	
		<i>"The Life Cycle of Civilizations" by Stephen Blaha</i>	
		<i>"Into the Buzzsaw" edited by Kristina Borjesson</i>	
		REVIEWS—DVD/Video.....	72
		<i>"Crop Circles: The Ultimate...Investigation" by J. H. Gibsone</i>	
		REVIEWS—Videos.....	72
		<i>"Peru's Mystery in Stone" from Terra Entertainment</i>	
		<i>"Holistic Therapies - Demonstrations" from E & E Productions</i>	
		REVIEWS—Music.....	73
		<i>"Cover the World" by various artists</i>	
		<i>"Fields of Green" by Paul Benhaim Hemp Plastic Music</i>	
		<i>"El Sultaan - Classical Egyptian Dance" by Hossam Ramzy</i>	
		<i>"Buenos Hermanos" by Ibrahim Ferrer</i>	
		<i>"Over Nine Waves" by Rebecca Hood</i>	
		NEXUS BOOKS, VIDEOS, ADS, SUBS.....	78-88

NEXUS MAGAZINE

Volume 10, Number 5

AUGUST – SEPTEMBER 2003

PUBLISHED BY

NEXUS Magazine Pty Ltd, Australia

EDITOR

Duncan M. Roads

CO-EDITOR

Catherine Simons

ASSISTANT EDITOR/SUB-EDITOR

Ruth Parnell

OFFICE ADMIN/EDITORS' ASSISTANT

Jenny Hawke

UK Office Manager

Marcus Allen

CONTRIBUTORS THIS ISSUE

Ann Martin; Walter Last; Will Banyan;

David G. Guyatt; ERE & Trevor James Constable;

Jerry W. Decker; Iona Miller and

Richard Alan Miller; Marius Boirayon

CARTOONS

Phil Somerville

COVER GRAPHIC

John Cook, jscook@ozzinet.net

PRINTING

Goodhed Print Group, Bicester, Oxon., UK

DISTRIBUTION

Seymours, London, UK

UK OFFICE - 55 Queens Rd, East Grinstead,
West Sussex, RH19 1BG.

Ph: 01342 322854; Fax: 01342 324574

e-mail address: nexus@ukoffice.u-net.com

Website: www.nexusmagazine.com

EUROPE OFFICE - PO Box 48, 1600 AA

Enkhuizen, The Netherlands.

Ph: +31 (0)228 324076; Fax: +31 (0)228 312081

e-mail address: nexus@fsf.nl

HEAD OFFICE - Articles, Reviews, etc.

PO Box 30, Mapleton, Qld 4560, Australia.

Ph: +61 7 5442 9280; Fax: +61 7 5442 9381

e-mail address: editor@nexusmagazine.com

ITALY OFFICE - c/- Avalon Edizioni, Piazza

Mazzini 52, 35137 Padova, Italy

Ph/Fax: +39 (0)49 912 6006

e-mail address: info@nexusitalia.com

USA OFFICE - 2940 E. Colfax, #131,

Denver CO 80206 USA

Tel: 303 321 5006; Fax: 720 941 9352

E-mail: nexususa@earthlink.net

STATEMENT OF PURPOSE

NEXUS recognises that humanity is undergoing a massive transformation. With this in mind, NEXUS seeks to provide 'hard-to-get' information so as to assist people through these changes. NEXUS is not linked to any religious, philosophical or political ideology or organisation.

PERMISSION-TO-REPRODUCE POLICY

While reproduction and dissemination of the information in NEXUS is actively encouraged, anyone caught making a buck out of it, without our express permission, will be in trouble when we catch them!

Editorial

World geopolitical manoeuvrings are taking place at rapid speed. I cannot help but feel as though the forces behind the UK/USA alliance have an unhealthy confidence in themselves. Are they bluffing the world with their blatant grab for global dominance—or do they have a new level of secret technology to back up their belligerence?

We have several news items this issue which look at some of the known technological plans of the USA, including its desire to dominate Earth from space using space-based weapons systems. I find myself wondering whether some of this new weapons technology has already been tested in the field, starting back with the "intervention" in the Balkans. Strange stories are now emerging from Afghanistan which indicate that a new type of radioactive weapon was used there, and the signs are only just being seen medically in the form of the resultant human suffering.

Is the USA going it alone? Or does the weight of the UKUSA pact mean that both nations are in it together when it comes to high-level decision-making that really counts?

The rumours that the USA and UK are sharing secret technology derived from captured/crashed UFOs just won't go away. As well as the slow but steady stream of leaked documents and insiders offering to tell all if given indemnity from prosecution, there are signs that countries such as Russia are wanting to reveal what they know about UFOs and related technology. Russia has repeatedly voiced strenuous opposition to the USA's plans for domination of space, and would appear to be on the outside when it comes to power-sharing up there. What better way to level the playing field than to let slip some of the USA's secrets? It could be argued that this position is also close to that of France. Its COMETA report into UFOs, which was compiled by top government scientists and military people, basically said that UFOs *do* exist. It revealed French concerns that the USA is not allowing the open international sharing of information on the subject. I have been told "off the record" several times that it is the UKUSA pact that pressures other countries into silence on the subject of UFOs and related technology. It is a subject we will be following in future issues.

Back to this issue of NEXUS. First up is an article on the pet food industry and its questionable practices. A few years ago we ran a compilation of items on the subject, and we still get feedback about it. Much has transpired since, and it is not all good news. This update addresses the problems and issues concerning what's in pet food, but also reveals some of the horrible experiments that US pet food manufacturers and universities conduct on companion animals in testing commercial pet food. While calling on pet owners to boycott unsafe brands, it also makes suggestions about healthier alternatives.

The Project Hammer article we are publishing has already attracted interest of the unpleasant kind for writer David Guyatt. Well known for his investigations and research into dodgy dealings involving big banks and slush funds, Guyatt has had alarming reminders of his vulnerability left at his front door (as you'll see in this issue's Letters pages). Hopefully, now that his article is in the public domain, such threats will cease.

You *must* read the article on Dr Hamer and his research into the shock-conflict mechanism behind cancer development. This article opens up research we hope to expand on with other approaches in upcoming issues, such as the Adam Technology.

There's another interesting development in health research covered in Jerry Decker's article about an Aura Therapy Machine. Jerry is the front man for KeelyNet (<http://www.keelynet.com>), which is my favourite resource site on the Internet for all aspects of alternative science and technology. I've always found that if Jerry is convinced something is the real thing, it *is* the real thing!

Just when I thought I couldn't be amazed by anything else, along comes another surprise. Last issue we published a letter about strange flying craft and abductions in the Solomon Islands, asking if any readers knew more. Well, one reader certainly does know more, and we have put just some of his experiences and findings about UFOs, aliens and giant races into this issue. It is interesting that an international force of thousands of soldiers is being sent to the Solomon Islands, right to where those giants and the strange tunnels/installations are supposed to exist. NEXUS plans to organise a group of interested people to travel there and see for ourselves what's going on.

Duncan

WARRANTY AND INDEMNITY

Advertisers upon and by lodging material with the Publisher for publication or authorising or approving of the publication of any material INDEMNIFY the Publisher and its servants and agents against all liability claims or proceedings whatsoever arising from the publication and without limiting the generality of the foregoing to indemnify each of them in relation to defamation, slander of title, breach of copyright, infringement of trademarks or names of publication titles, unfair competition or trade practices, royalties or violation of rights or privacy AND WARRANT that the material complies with all relevant laws and regulations and that its publication will not give rise to any rights against or liabilities in the Publisher, its servants or agents and in particular that nothing therein is capable of being misleading or deceptive or otherwise in breach of the Part V of the Trade Practices Act 1974. All expressions of opinion are published on the basis that they are not to be regarded as expressing the opinion of the Publisher or its servants or agents. Editorial advice is not specific and readers are advised to seek professional help for individual problems.

© NEXUS New Times 2003

Letters to the Editor ...

The Healthiest Drinking Water

Dear Duncan: Having been in the alternative health industry for over 36 years now, I have seen products come and go. It is rare indeed to come across a product that not only stands up to scientific scrutiny but works in a practical sense as well. I speak of the Wellness water filter.

My wife and I just renovated our kitchen and decided to install the Wellness unit. We must say that we have never experienced such a joy from just drinking water. We have used and installed many other types of filters over the years with varying degrees of success in obtaining "natural" water with that special taste of fresh clean spring water.

I have always said (and it is now called "Shaw's Law"), "Put nothing in your body unless it is natural and can be found in Nature". The Wellness filter would be the closest thing yet to fulfilling that circumstance.

The above statement is made with good intentions, as the writer feels that every reader of NEXUS should have the opportunity to use a water filter that is really fantastic.

Joshua Shaw, Queensland, Australia, bionic@bigpond.net.au

Death Threats and Black Gold

NEXUS magazine is currently publishing a two-part continuation of my earlier two-part essay on Project Hammer [see 9/01-02].

I can say with some degree of certainty that my investigation into Project Hammer has caused concern in some quarters. Last Saturday night/Sunday morning, 21/22 June, someone delivered to my house a cheap-fibre briefcase containing a litre bottle of petrol. A further litre bottle of petrol had been opened and poured over the briefcase. Next to it was a box of matches that had been up-ended and tipped out on the floor. Nearby, another box of matches had been similarly strewn about the driveway.

This is the second death threat I have received in the last seven months. Previously, in early November last year, someone delivered to precisely the same spot on my driveway a dead pig's head, a length of rope, a brick (very masonic, à la Roberto Calvi) and a blank bereavement card (and a couple of other items, too).

On at least a dozen occasions—maybe as many as 20, now—the gate leading to the side of my house, which is always kept shut, has been in an open position when my wife and I have returned home from visiting family, etc.

This latest death threat was also reported to the police. Although I was interviewed and lodged formal complaints, the police appear to have been all too casual and have taken no real action.

Project Hammer reveals a decades-old network that indirectly connects to the JFK assassination on one hand and 9-11 on another. But Hammer's principal focus is the gold plundered during WWII by the Japanese and the Nazis and how it has been used since WWII in all manner of covert activities. We are talking about a 60-year-old slush fund that is currently valued in the trillions of dollars.

It is here, in this maelstrom of money, that one can see the convergence of different but not altogether unrelated interests: the intelligence community, organised crime, awfully powerful and wealthy families, transnational businesses and members of the political class.

It just may be that it is this WWII black gold that is the binding thread behind the numerous—but seemingly unconnected—events of past decades.

David Guyatt, UK, website <http://www.deepblacklies.co.uk>

Horrors of Hurricane Andrew

[This letter was sent to author k.t. Frankovich, who forwarded it to us for publication. Ed.]

I happened to be surfing for information on hurricane Andrew, and came upon your article [see NEXUS 8/03 and our website]. I was a volunteer rescue coordinator for a coalition of humane societies interested in helping the surviving pets of hurricane Andrew survivors by taking care of them until their owners were able to do so.

I was in Cutler Ridge the day after Andrew...and I saw everything you described in your article. I tried to tell many people about the refrigerated trucks full of body bags, but was told that I must have been suffering from post-traumatic shock, and that I really didn't see what I thought I had seen.

I also saw National Guardsmen

randomly shooting and killing any living animal they came into contact with, as they had been told that any animals which survived could become contaminated with rabies.

I also saw the National Guard shoot and kill someone I believe was a migrant worker who was hysterical, much the same as you were. All I can say is that for more than 10 years I have lived with the horror I had witnessed, only to be told it never happened. Now you have changed all that.

I made three more trips to Miami from my home in central Florida to aid people I met during that first trip, and have many more horror stories that authorities have told me "never happened".

At least now I know my nightmares are more than that...they are my remembrances of an experience that will live with me forever. Thank you for what you have done for me.

Ann-Marie S., via k.t. Frankovich, KFnkovich@aol.com

Fluorescent Lighting Problems

G'day Duncan: My family have been readers of NEXUS since its first edition, and we have been following many of these subjects for over 40 years.

Your recent article on Incandescent Light (10/04-05) missed a bit. Years ago, students in the USA were looking at employment records and noted that those who worked outdoors had a better attendance record, fewer "sickies", less marital discord, longer marriages and better overall health, fertility and work disposition. Their summary was that sunlight is great for your health and that artificial, predominantly fluorescent, lighting is bad. Why?

At about that time a researcher was looking at the hypothalamus gland in poultry, and found it had a direct reaction to sunlight and health benefits. In studies it was shown the same effect was in humans too; as a result of those studies it is now compulsory in most US states for daylight spectrum light tubes to be used in fluorescent lighting work areas, which solved the problem. This had been well known for years by aquarium owners who used that lighting to keep their aquariums healthy, it also works with terrariums. (Conversely if your fish die and

indoor plants are crook, move them away from your TV.)

All photographers know the problems of using artificial light—red from tungsten bulbs, whites and blues from most others, unless daylight tubes and 3200 K tungsten bulbs are used. We have all seen the pink-red fluoro tubes to improve the appearance of meat in butcher's shops.

A very important factor that is often unknown is that it is very common for people to become irritable when under non-daylight fluorescent tubes for long periods. I have seen very serious family discord cease when, on advice, all the tubes were changed to daylight spectrum. Any readers who have fluoro tubes should change them to daylight spectrum; there is a very real benefit.

Cheers, Gil May, Tyalgum, NSW, Australia, gilmay@coolgold.com.au

Dangers of High-Voltage Lines

Dear Duncan: The rural communities of Tully and Innisfail in north Queensland have since 1999 been opposing the Queensland Government's desire to relocate existing high-voltage transmission lines from state forest to private freehold land.

This is no different to what is happening by stealth in other rural areas, such as near Toowoomba and the Coomera Valley on the Gold Coast.

All of these people are hard pressed to counteract such tactics in what becomes an overwhelming and all-consuming effort to save your land, your children's lives and those in your community.

I nursed by husband as he died from leukaemia in 1997, and there was then a credible wealth of information in regard to the effects of electromagnetic radiation and there is even more now.

As the coordinator of the action group preserving the rural valley wedged between World Heritage-listed reef and rainforest of north Queensland, I communicate with scientists around the world on this issue. Most notable is Professor Dennis Henshaw of Bristol University, who is a member of the UK National Radiological Protection Board and is advancing his studies of the links between lung cancer and the corona effect

... more Letters to the Editor

NB: Please keep letters to approx. 150 to 250 words in length. Ed.

produced by the ionising radiation of high-voltage transmission systems.

This reminds me of an instance when I worked for the Northern Territory Electricity Commission in the mid-1980s, before I married and before I'd heard of leukaemia. Back then, when people like me complained about the effects of EMR, part of my duties was to respond. In one of the instances at the time, I recall signing confidentiality clauses to access United States electricity supply authority records which stated that the highest rates of leukaemia were attributed to the high-voltage transmission linesmen and associated personnel.

The subsequent United States Environmental Protection Agency report was not released in the late 1980s—however, all around the world, but most importantly in this so-called "Smart State" of Queensland, we are still faced with compulsory resumption of freehold land for government-owned revenue-making community infrastructure.

Even as world evidence shows a doubling of the rate of leukaemia in children at exposures above four milligauss, Australia has not reviewed the 1989 ARPANSA standards saying exposure is safe at 1,000 milligauss.

The governments have abrogated all duty of care, and pursue wealth before people's health. We, the people, are again the unwitting canaries in the coalmine.

Bonny Bauer, Tully, Qld, Australia, bonnyb@bigpond.com

Side Effects of Specialists

Dear Duncan: Your remarks in the Editorial of NEXUS 10/04 regarding the proposed enquiry into the safety of alternative medication is a concerted effort by the medical and pharmaceutical fraternity to stamp out the ever-increasing competition. It would be more appropriate and necessary to have the government initiate an enquiry into the side effects of treatments and drugs administered by our medicos. I would like your readers to know what happened to me recently.

At Easter, I was diagnosed with prostate cancer. It was classed by the pathology laboratory as 9 on the Gleason scale and a Grade C prostate cancer. Since pathology

stated that the cancer had already spread outside the gland, surgery was not an option. The specialist put me on hormonal therapy, i.e., Androcur-100, two tablets a day, starting 17 April. On the 30 April, I saw the specialist again and he told me to see him in three months' time and have a blood test done then.

The blurb which comes with the medication gives some side effects such as tiredness and shortness of breath as the most common. I felt I could live with that, and actually did. What it also stated was that "Androcur-100 can rarely cause severe damage to your liver, resulting in jaundice, hepatitis and, in some cases, death". The specialist never even mentioned this during the consultation. I realised afterwards that I could not possibly accept the fact that he did not ask to monitor the progress of the treatment for a period of three months, so I asked my GP to have monthly blood tests done.

On 31 May, six weeks after the start of the treatment, the results of the test showed my liver was diseased. Needless to say, I immediately ceased taking the drugs. Can you imagine what would have happened to me if I had followed the "specialist's" advice and taken the medication for a further two months?

Sincerely yours, Colin Zentveld, Sydney, NSW, Australia

Earth's Frequency Changes OK

Duncan: I read with interest your recent article [10/03] which suggested the Schumann resonance has been rising from a frequency of 7 Hz to around 11 Hz; however, I see no cause for concern.

The reason I believe this is because of the impending magnetic pole reversal. The ionosphere has a symbiotic relationship with the Earth's magnetic field. As the Earth's magnetic field weakens approaching such a pole-reversal event, the ionosphere contracts and—just as when, for instance, a pipe is shortened in a pipe organ—the resonant frequency rises.

This is not an inherently bad thing and could have a significant contribution to the evolution of our species, as DNA changes due to changing magnetic and cosmic ray exposure will be specifically enhanced during these cyclical

transitional periods in time.

Regards, Aled Long, schmal@utvinternet.com

The Man-Made AIDS Agenda

Duncan: Though it has probably been documented before in your excellent magazine, I feel the need to put voice to some information that has conveniently slipped under the collective noses of the "conventional" media.

It has been revealed, through the declassification of top-secret military documents and the shrewd detective work of one Boyd E. Graves, JD, that the plague of the late 20th century, AIDS, was in fact man-made [see Global News, NEXUS 10/02].

The United States' Special Virus Program's 1971–1978 flowcharts, discovered by Mr Graves in 1999, detail a diabolical plot by the US military to depopulate black populations in America and Africa. The AIDS virus, then described as a "contagious cancer that selectively kills", was attached as a complement to vaccines sent to Africa and Manhattan.

This next-generation holocaust is the dark legacy of Hitler, stemming from the infamous Operation *Paperclip* in which Nazi scientists were given amnesty to work for the US military. It was undoubtedly put into action by President Nixon, whose 1969 and 1970 national security memos regarding "overpopulation" leave no doubt as to the US government's attitude towards black populations at the time.

Boyd Graves has embarked on a personal crusade to bring the individuals responsible for this atrocity to justice, time and time again bringing the case to Congress and the Supreme Court and being repeatedly turned away, the case dismissed as "frivolous".

These claims can all be verified; however, the volumes of information involved are too great for me to document here. I highly recommend that you visit <http://www.boydgraves.com> for the full story.

J.E., cloakand_dagger@lycos.com

Radiation from Light Ballasts

Dear NEXUS: In your article on fluorescent light (10/03), it is not made clear that high-frequency bal-

lasts generate a considerable amount of radio-frequency radiation. Extensive use of this type of lighting in schools and office buildings has become one of the most ubiquitous (but little-known) sources of electromagnetic pollution. It could be reduced by shielding, but manufacturers of light fixtures don't bother because to do so would be prohibitively expensive.

Incidentally, the EMR Association of Australia publishes a quarterly newsletter of "non-nonsense" information on health effects of EM radiation; see website <http://www.emraa.org.au>.

John Lankes, Virginia, USA

Private Oilwells Destroyed

Dear NEXUS Magazine: In 1995, a group of men working for a US senator and the governor of Louisiana entered our south Louisiana oilfield with guns and attack dogs and began destroying our 22 oilwells—our privately owned oilwells. We were held at gunpoint while our oilwells were destroyed by bulldozers, electric pipe cutters and other types of heavy equipment. After the pumping units were knocked down, the wells themselves—all good, productive oilwells—were filled with cement.

No reason was given to us for the action, and it was all done in the face of a US federal law called RCRA (Resources Conservation and Recovery Act), which has been in place since the 1930s and was beefed up again in 1988. The federal law specifically protects all US oilwells, their owners, the ground they sit on, and everything that comes out of an oilwell which is stated in the law as "oil, gas, produced saltwater and hydrocarbon-bearing soils".

After my husband filed several lawsuits in federal court, he was murdered. I know it was the US senator who called for my husband's death. (The governor who was involved has since gone to federal prison on an unrelated charge. The senator is still in office.)

I would like to write a story for NEXUS about what happened and who did it, and I can provide a few pictures that I managed to take.

Floy Hochenedel, LA, USA

[Dear Floy: Feel free to write your amazing story and send it; hopefully I'll be able to publish it. Ed.]

THE GRID: THE NEXT INTERNET REVOLUTION

It is called the Grid, and scientists say that before long it will change everything we do, from scientific research to business to tackling fires to booking holidays and even to the way we watch and craft movies.

The Internet currently consists of huge servers which contain information on web pages that is then downloaded onto computers. As a user, you are limited in what you can do with that information by how much memory or processing power your own computer has.

Under the Grid, the power of your machine—all the gigabytes, RAM and gigahertz—becomes irrelevant. No matter how primitive and cheap your computer, you will have access to more computing power than currently exists in the Pentagon.

A small handheld computer, connected by mobile phone to the Internet, would become a supercomputer. Movies could be edited and watched on it. It could access a word processor that is stored on a computer somewhere in cyberspace.

Bob Jones, a Grid project manager who was at CERN when the original web was invented, talks of applications in biology. More and more genomes are being sequenced, producing masses of information, so the Grid is the perfect means for analysing and sharing that data, he says.

"It took eight years for the Internet to catch on," he says. "This time, governments and scientists are already on board,



so the results will be seen far quicker. It'll be like the web: when you have it, you'll wonder how you ever got by without it." (Source: The Guardian, July 3, 2003)

LIFELOG: DARPA'S PROPOSED SURVEILLANCE DATABASE

The Pentagon is about to embark on a stunningly ambitious research project designed to gather every conceivable bit of information about a person's life, index all the information and make it searchable.

The embryonic LifeLog program would dump everything an individual does—every email sent or received, every picture taken, every web page surfed, every phone call made, every TV show watched, every

magazine read—into a gigantic database.

All of this and more would be combined with information gleaned via a variety of sources—a GPS transmitter to keep tabs on where that person went, audio-visual sensors to capture what he or she saw or said, and biomedical monitors to keep track of the individual's health.

According to a briefing from the Defense Advanced Projects Research Agency (DARPA), LifeLog's sponsor, this vast amalgamation of personal information could then be used to "trace the 'threads' of an individual's life" to see exactly how a relationship or events developed. Someone with access to the database could "retrieve a

specific thread of past transactions, or recall an experience from a few seconds ago or from many years earlier...by using a search-engine interface".

(Source: Wired, May 20, 2003, <http://www.wired.com>)

PENTAGON EYES NEW BIG BROTHER SPYING SYSTEM

The US Department of Defense is also developing a surveillance system which is designed to track and analyse the movement of every vehicle in a city.

Known as "Combat Zones That See", the project is intended to help the US military protect troops and fight in cities overseas, but scientists and privacy experts say the unclassified technology could also easily be adapted to keep tabs on civilians at home.

The project's centrepiece would be groundbreaking computer software capable of automatically identifying vehicles by size, colour, shape and licence plate, or drivers and passengers by face.

The Pentagon's program "aspires to build the world's first multi-camera surveillance system that uses automatic... analysis of live video" to study vehicle movement "and significant events across an extremely large area".

DARPA, which is overseeing the project, told more than 100 executives of potential contractors in March that 40 million cameras already are in use around the world, with 300 million expected by 2005. (Source: Wired, July 2, 2003, <http://www.wired.com>)



... GLOBAL NEWS ...

WEBSITE SERVICE KEEPS TABS ON GOVERNMENT OFFICIALS

Annoyed by the prospect of a massive new federal surveillance system, two researchers at the Massachusetts Institute of Technology celebrated the Fourth of July by announcing a new Internet service that lets citizens create dossiers on government officials.

The system will start by offering standard background information on politicians and officials, but then will go one bold step further by asking Internet users to submit their own intelligence reports on government officials.

"It's sort of a citizens' intelligence agency," said Chris Csikszentmihalyi, Assistant Professor at the MIT Media Lab.

He and graduate student Ryan McKinley created the Government Information Awareness (GIA) project as a response to the US government's Total Information Awareness (TIA) program.

Revealed last year, the TIA aims to track possible terrorist activity by analysing vast amounts of information, including credit card data, stored in government and private databases. The actions of millions of people would be analysed in an effort to spot patterns that could indicate terrorist threats.

News of the plan outraged civil libertarians and prompted Congress to set limits on the scope of such activity. The Defense Department then renamed the program Terrorist Information Awareness, to ease public concern.

However, the controversy gave McKinley the idea for the GIA project.

"If total information exists," he said, "really, the same effort should be spent to make the same information at the leadership level at least as transparent—in my opinion, *more* transparent."

The result is a one-stop research site for basic information on key officials. It can be accessed via <http://opengov.media.mit.edu>.

(Source: Boston Globe, July 4, 2003, http://www.boston.com/dailyglobe2/185/business/Website_turns_tables_on_government_officials+.shtml)

SOLAR FLARE ACTIVITY AFFECTS EARTH'S TEMPERATURE

A recent study by researchers at Duke University and the US Army Research Office has found new evidence of a link between solar flare activity and the Earth's temperature. The work is another contribution to the ongoing debate over global warming and its causes. A strong link, if it exists, between solar flares and our climate could override the influence humans have on the temperature of our environment.

One of the challenges of determining the connection between solar flare activity and the atmosphere stems from the fact that the motion of the air that blankets our planet is turbulent and complex. A sudden burst of solar activity would, in effect, be smeared out by moving air and its interaction with the Earth's surface. Any temperature increase caused by a given period of solar flare activity would be difficult to determine, at best.

Rather than focus on such challenging one-to-one correlations, the new study compares the form of the statistical fluctuations in solar flare activity with the form of the statistical fluctuations of the Earth's temperature. The researchers found that a comparison of the mathematical coefficients that describe the fluctuations shows that the atmosphere directly inherits its temperature fluctuations from the variation in solar flare activity.

Unless some other underlying cause is

responsible for the unlikely correspondence between solar flares and the Earth's temperature, the research suggests that, for the large part, variations in global temperatures are beyond our control and are instead at the mercy of the Sun's activity. (Source: Paper by Nicola Scafetta and Bruce J. West, Physical Review Letters, June 20, 2003; release at <http://www.aip.org/enews/physnews/2003/split/642-2.html>)

USA AIMS TO CONTROL SPACE

The United States is planning to take control of parts of space and develop patrolling military aircraft in orbit as part of a revived "Star Wars" proposal for an American military empire above the ozone layer.

According to James Roche, the US Air Force Secretary, America's allies would have "no veto power" over projects designed to achieve American military control of space.

The key theme of the ambitious plan is described as "negation"—the denial of the use of space for military intelligence, or other purposes, without US endorsement.

The National Reconnaissance Office (NRO), the intelligence agency that is responsible for US spy satellites, is to develop a strategy that ensures America's allies, as well as its enemies, never gain access to the same space resources without Washington's permission. Recent proposals that have been circulated at Space Command and NRO briefings suggest that access to "near-Earth space" may be refused to other nations. All GPS satellites are located within near-Earth space, which covers the orbital distance from Earth to the Moon.

A fleet of spacecraft will be developed, designed to attack and destroy future satellites of enemies and rivals. The rapid-



launch "military space plane", the potential cost of which has not been disclosed, would also be used as a mobile "body-guard" for US space installations. It would be the first "space plane" in history designed just for a military function. A prototype is expected by 2005, although military deployment is not expected before 2014.

"It will hopefully be a new kind of vehicle, equipped for the challenges of the future," said a Pentagon official.

The Pentagon believes that the struggle to control space will form the next stage of a global arms race.

Until now, international treaties have forbidden the deployment of weapons in outer space, although a loophole exists which allows the United States to use its satellites for military intelligence.

The 1967 Space Treaty—the first international legislation on space exploitation—also stated that outer space should be free for exploration and use by *all* states, and would not be subject to national appropriation by occupation or any other means.

A US Department of Defense Review in 2001 also stated that "a key objective [for the US] is not only to ensure US ability to exploit space for military purposes but also as required to deny an adversary's ability to do so".

Canadian government officials have already complained that senior US officials have begun to exclude them from sensitive areas of joint aerospace defence operations.

The implications of a United States military monopoly in space are bound to con-

cern European allies, which have long resisted the prospect of military use of space technology.

In May, Russian foreign minister Sergei Ivanov repeated Moscow's demands for the complete demilitarisation of space.

(Source: Daily Telegraph, UK, June 8, 2003, <http://www.telegraph.co.uk/news/main.jhtml?xml=/news/2003/06/08/wspace08.xml>)

WERE RADIOACTIVE WEAPONS USED IN AFGHANISTAN?

A small sample of Afghan civilians has shown "astounding" levels of uranium in their urine, according to an independent scientist.

Dr Asaf Durakovic, Medical Director of the Uranium Medical Research Centre (UMRC) based in Toronto, Canada, suspects that *new* types of radioactive weapons were used in Afghanistan, as no traces have been found of the depleted uranium (DU) that some scientists believe is implicated in Gulf War syndrome.

Dr Durakovic is a former US Army adviser and now a professor of medicine. In 2000, he found "significant" DU levels in two-thirds of the Gulf veterans he had tested. In May 2002, he sent a team to Afghanistan to interview and examine civilians there for uranium contamination.

During the Afghanistan conflict in 2001–02, Nangarhar province was a strategic target zone for the deployment of a new generation of deep-penetrating, "cave-busting", seismic-shock warheads.

The UMRC says its team identified several hundred people suffering from illnesses and conditions similar to those of Gulf War veterans, probably because they had inhaled uranium dust.

To test its hypothesis that some form of uranium weapon had been used, the UMRC sent urine specimens from 17 Afghans for analysis at an independent UK laboratory. Some of the patients were from Jalalabad, and others from Kabul, Tora Bora and Mazar-e-Sharif.

"Without exception, every person donating urine specimens tested positive for uranium

internal contamination. The results were astounding: the donors presented concentrations of toxic and radioactive uranium isotopes between 100 and 400 times greater than in the Gulf veterans tested in 1999. If UMRC's Nangarhar findings are corroborated in other communities across Afghanistan, the country faces a severe public health disaster... Every subsequent generation is at risk."

Dr Durakovic said: "In Afghanistan there were no oil fires, no pesticides, nobody had been vaccinated—all explanations suggested for the Gulf veterans' condition. But people had exactly the same symptoms. I'm certainly not saying Afghanistan was a vast experiment with new uranium weapons. But use your common sense."

The UK Defence Ministry says that in Afghanistan it used no DU weapons nor any others containing uranium in any form.

A spokesman for the US Department of Defense told BBC News Online that the US had not used DU weapons there.

(Source: BBC News Online, May 22, 2003, <http://news.bbc.co.uk/1/hi/sci/tech/3050317.stm>; also see <http://www.umrc.net/index.asp>)

NEW US-BASED WEAPONS TO HAVE GLOBAL REACH

Allies are to become less important, as a new generation of weapons will enable the USA to strike anyone, anywhere—from within its own territory.

The Pentagon is planning a new generation of weapons, including huge hypersonic drones and bombs that can be dropped from space, which would free the US from dependence on forward bases and the cooperation of regional allies.

The new weapons are being developed under a program code-named FALCON (Force Application and Launch from Continental US).

According to DARPA, the ultimate goal is a "reusable hypersonic cruise vehicle (HCV)...capable of taking off from a conventional military runway and striking targets 9,000 nautical miles distant in less than two hours". The unmanned HCV would carry a payload of up to 12,000 pounds and fly at speeds of up to 10 times the speed of sound. DARPA estimates it will take more than 20 years to develop.

Meanwhile, over the next seven years the US Air Force and DARPA will develop a cheaper "global reach" weapons system relying on expendable rocket boosters



known as Small Launch Vehicles (SLVs) which would take a warhead into space and drop it over its target.

In US defence jargon, the warhead is known as a Common Aero Vehicle (CAV), an unpowered bomb which would be guided on to its target as it plummeted to earth at high and accelerating velocity.

The CAV could carry 1,000 pounds of explosives, but at those speeds explosives may not be necessary. A simple titanium rod would be able to penetrate 70 feet of solid rock and the shock wave would have enormous destructive force. It could be used against deeply buried bunkers—the sort of target the Air Force is looking for new ways to attack.

(Source: The Guardian, UK, July 1, 2003, <http://www.guardian.co.uk/us/story/0,12271,988612,00.html>)

LEADING CANCER RESEARCHER OPPOSES WATER FLUORIDATION

Dr Sam Epstein, Professor Emeritus of Environmental and Occupational Medicine at the University of Illinois, Chairman of the Cancer Prevention Coalition and author of *The Politics of Cancer*, wrote on 29 May in support of British MP John Butterfill's motion (EDM 1258) opposing water fluoridation:

"Fluoridation of water reflects high receptivity to the fluoride industry, and indifference with significant public health penalties to the UK population. I should further note that some 100 leading national and international cancer prevention scientists and representatives of consumer and environmental organizations have endorsed the Cancer Prevention Coalition's opposition to fluoride in its Stop Cancer Before It Starts campaign report.

"Fluoride used for this purpose comes from highly contaminated industrial-grade fluorosilicic wastes; contaminants include heavy metals. Furthermore, there is significant experimental evidence that fluoride induces a dose-related incidence of bone cancer in rats. This is further supported by epidemiological studies incriminating fluoride and bone cancer in young men.

"It should further be noted that fluoride is currently added to the water supply of about 60% of the US population. This is in sharp contrast to only 2% of the European population, which has much lower rates of dental caries."

(Source: UK National Pure Water Association press release, June 5, 2003, <http://www.npwa.freeserve.co.uk>)

THE CRIMES OF THE PHARMACEUTICAL INDUSTRY

IN THE NAME OF THE PEOPLE OF THE WORLD

Complaint Against Genocide and Other Crimes Against Humanity
Committed in Connection with the Pharmaceutical "Business with Disease"
and the Recent War Against Iraq

This complaint is submitted to the International Criminal Court
by Matthias Rath, MD, and others on behalf of the people of the world.
The Hague, June 14, 2003

This complaint brings before the International Court of Justice (ICC) the greatest crimes ever committed in the course of human history. The accused are charged with causing injury to and the death of millions of people through the "business with disease", war crimes and other crimes against humanity. These crimes fall under the jurisdiction of the International Criminal Court.

The accused know that they will be held accountable for these crimes, and they have therefore embarked on a global campaign to undermine the authority of the ICC in order to put themselves above international law and continue their crimes to the detriment of all mankind. Therefore, the current complaint must be considered by the ICC with utmost urgency. Moreover, every natural person and every government is hereby called upon to join this complaint, with the goal to once and for all terminate these crimes.

The charges presented in this complaint relate to two main fields of crime:

- Genocide and other crimes against humanity committed in connection with the pharmaceutical business with disease.
- Crimes of war and aggression and other crimes against humanity committed in connection with the recent war against Iraq and the international escalation towards a world war.

These two fields of crime are directly related and connected by one factor: they are committed in the name and interest of the same corporate investment groups and their political stakeholders.

Throughout the 20th century, the pharmaceutical industry was built and organised with the goal of controlling healthcare systems around the world by systematically replacing natural, non-patentable therapies with patentable and therefore profitable synthetic drugs. This industry did not evolve naturally. To the contrary, it was an investment decision taken by a handful of wealthy and unscrupulous entrepreneurs.

The accused are responsible for the deaths of hundreds of millions of people who continue to die from cardiovascular disease, cancer and other diseases that could have been prevented and largely eliminated long ago. This premature death of millions of people is the result of neither coincidence nor negligence. It has been wilfully and systematically organised on behalf of the pharmaceutical industry and its investors, with the sole purpose being to expand a global drug market worth trillions of dollars.

The marketplace of the pharmaceutical industry is the human body, and its return on investment depends on the continuation and expansion of diseases. Its profits depend on the patentability of drugs, rendering this industry the most profitable industry on planet Earth. In contrast, the prevention and eradication of any disease significantly reduces or totally eliminates the markets for pharmaceutical drugs.

The governments of entire nations are manipulated or even run by lobbyists and former executives of the pharmaceutical industry. For decades, the legislation of entire nations has been corrupted and abused to promote this multitrillion-dollar "business with disease", thereby risking the health and lives of hundreds of millions of innocent patients and people.

A precondition for the rise of the pharmaceutical industry as a successful investment business is the elimination of competition from safe and natural therapies, because these are not patentable and their profit margins are small. In addition, these natural therapies can effectively help prevent and eliminate diseases because of their essential roles in cellular metabolism. As a result of the systematic elimination of natural health therapies and the takeover of the healthcare systems in most countries of the world, the pharmaceutical industry has brought millions of people and almost all nations into dependency upon its investment business.

[Editor's Note: To read the complete 36-page document, visit Dr Matthias Rath's website at <http://www.4-dr-rath-foundation.org/>]

THE PET FOOD INDUSTRY AND ITS QUESTIONABLE PRACTICES

The pet food industry must be regulated to ensure that foods destined for our pets are safe, contain only ingredients fit for human consumption, and involve no animal experimentation.

by Ann N. Martin © 2003

Web page:
<http://www.newsagepress.com/foodpetsdiefor.html#author>

January 1990 was when my research and investigation began into the commercial pet food industry. Prior to 1990 I had always fed my pets—dogs and cats—a commercial pet food. This changed when after feeding my two dogs, a Saint Bernard and a Newfoundland, a well-known brand of dog food—a brand that I had fed them for a few years—both dogs became ill with vomiting and excessive thirst. Our veterinarian, an English gentleman, advised me to put them on a home-made diet for a few days. Both dogs did very well on this diet of cooked hamburger, brown rice and grated vegetables. Two days later I switched them back to the commercial diet and encountered the same problems. Both the veterinarian and I were convinced there was something in the food that was causing the problem.

A private lab showed that the food contained excess levels of zinc at 1120 parts per million (ppm)—a level that would have caused the symptoms the dogs displayed—and over 20 other heavy metals. The pet food company chose to take the position that it was not responsible.

It was then that I contacted the Canadian Ministry of Agriculture and found that this is a virtually unregulated industry. Governments in the USA and Canada regulate the labelling of the food, the name and address of the company, the weight of the product, and whether it is made for a dog or cat—nothing more. So what else was going into these foods that we, the pet owners, were not aware of?

RENDERING COMPANION ANIMALS

A friend, a veterinarian in California, had advised me that euthanised dogs and cats from veterinary clinics and shelters were routinely rendered and used as sources of protein in pet food. As a Canadian, I never thought it would happen in Ontario, the province where I live. Wrong! I was to discover that almost every veterinarian clinic in the city was using a dead-stock removal company that picked up the pets and sold them to a broker who then sold them to rendering plants in the province of Quebec. The rendering plant that was paying the highest amount at that time, Sanimal Group, was the party that usually purchased the dead animals.

The Minister of Agriculture in Quebec advised that dogs and cats were cooked along with other material. This material, as I later learned, contained the remains of so-called "4-D" (dead, diseased, dying and disabled) animals, slaughterhouse waste, roadkill, garbage from restaurants and grocery stores, and even zoo animals. The use of such ingredients is perfectly legal. Because well over 90% of the pet food sold in Canada is imported from the USA, I began my investigation into the industry in that country.

The Department of Agriculture (USDA) confirmed what the Canadian Ministry had advised, that this industry is self-regulated. The Association of American Feed Control Officials (AAFCO), a non-governmental body, oversees labelling text and provides a list of ingredients which can be used in livestock and pet food. Some of the ingredients listed include: hydrolysed hair, dehydrated garbage and even manure, swine waste, ruminant waste, poultry waste, and what is described as "undried processed animal waste products". Undried waste products are excreta from any animal except humans.

The Food and Drug Administration Center for Veterinary Medicine (FDA/CVM) oversees vitamins and mineral supplements as well as drugs such as antibiotics used in the food but, again, it has no input as to the sources of ingredients. As with AAFCO, the only input as far as ingredients are concerned relates to the labelling. If the label states that the product contains 24% protein, it must contain 24% protein—but the source of the protein

matters not. This also applies to any grains or fats in the foods.

The Pet Food Institute (PFI) is an association that represents the various interests of the pet food industry. Over the years the PFI has insisted that the companies they represent use only quality ingredients. Numerous times I have questioned this organisation as to what testing the pet food companies undertake to ascertain the sources of protein, the meat meal, which they purchase from rendering plants. They have chosen not to respond. Their silence says it all.

In the fall of 1997 my first book, *Food Pets Die For*, was published and people became aware of the dubious ingredients in some commercial pet foods. Pet owners were shocked that their euthanised pets could very well be ending up in pet foods. Naturally, the pet food industry denied that this was happening.

Not only was the rendering plant in Quebec accepting euthanised companion animals for rendering, but this practice was being carried on by a number of rendering plants in the US.

In a letter dated July 12, 1994, Christine Richmond, spokesperson for the FDA Division of Animal Feed, wrote: "In recognizing the need for disposal of a large number of unwanted pets in this country, CVM has not acted to specifically prohibit the rendering of pets. However, that is not to say that the practice of using this material in pet food is condoned by CVM." It is not condoned, but no steps have ever been taken to prohibit the use of dogs and cats in pet foods.

For the *Baltimore City Paper* (September 27, 1995), reporter Van Smith wrote an extensive article, replete with pictures, of his day riding with a truck from the Valley Proteins rendering plant. Smith describes how carcasses of zoo animals and "thousands of dead dogs, cats, raccoons, possums, deer, foxes, snakes, and the rest that local animal shelters and roadkill patrols must dispose of each month" are rendered. Pictures show barrels overflowing with dead dogs and cats waiting to be rendered.

On January 5, 2000, Florida's *Gainesville Sun* ran a story on the Alachua County Animal Shelter where the employees actually had to deliver the euthanised animals to the rendering plant. Reporter Paula Rausch wrote that the employees had to "lift them off the truck and heave them into a pit, exposing themselves to foul odors, putrid substances underfoot, and having to see the grinding going on". These duties were taking their toll on the staff at the shelter.

In March 2000, due to public outcry, Valley Proteins discontinued accepting dogs and cats, leaving shelters in a dilemma as to how to dispose of the animals in the Baltimore area.

Prior to the publication of the revised edition of *Food Pets Die For* (2003), I learned that Sanimal, the large rendering plant in Quebec, as of June 2001 was now refusing to accept the carcasses of dogs and cats. Reporter Philip Lee-Shanok, for the *Toronto Star* (June 7, 2001), interviewed Mario Couture, Sanimal's head of procurement, on the subject of euthanised pets rendered into pet food. Couture stated: "This food is healthy and good, but some people don't like to see meat meal that contains pets."

In 2001, I again contacted the Ministry of Agriculture in

Quebec and asked if any other rendering plants in Quebec were accepting and rendering dogs and cats. The reply was: "Yes, here is the establishment that now accepts cats and dogs: Maple Leaf, Inc." Maple Leaf Foods also owns Rothsay Rendering and Shur-Gain pet foods.

In January 2002, I contacted the Alachua County Animal Shelter in Florida and was pleased to learn that their employees no longer had to truck the euthanised animals to a rendering plant. They had now built a crematorium for disposal of animals.

In research for my second book, *Protect Your Pet*, it became evident that California operated more rendering plants and sent more pets for rendering than any other state in the USA. Reporter Sandra Blakeslee, in an interview published in the *New York Times* (March 11, 1997), quotes Chuck Ellis, a spokesman for the Los Angeles sanitation department: "Los Angeles sends 200 tons of euthanized cats and dogs to West Coast Rendering every month."

After acquiring a list of US shelters and veterinary clinics, I e-mailed 102 veterinarians in private practice in California and asked how they disposed of euthanised animals. Ninety per cent of the 78 veterinarians who responded stated that they sent the animals to rendering. The replies I received named two companies that picked up the animals from their facilities: D&D Disposal in California, and Koefran Services in Nevada.

An employee at a Humane Society branch in California wrote that in his area, Escondido, D&D Disposal picks up approximately 100 bodies each week. In the same area, there are three other shelters and more than 100 veterinarians using the same disposal company. D&D was rather hard to locate, but fortunately one shelter had a complete address for them. D&D shares the same address as West Coast Rendering in Vernon, California. Interestingly, Baker Commodities, another rendering plant notorious for rendering companion animals, is within a block of West Coast Rendering, as is a large pet food company that produces several popular brands of pet food.

Koefran Incorporated, the company that also picks up dogs and cats in California and Nevada, operates a rendering plant, Reno Rendering, in Reno, Nevada, and in Provo, Utah. In Utah, Koefran Services also picks up animal carcasses with the approval of county commissioners.

Have we turned our pets into cannibals?

CONTAMINATED GRAIN IN PET FOOD

As with the sources of proteins used in commercial pet foods, grains used in dry pet foods are materials unfit for human consumption. Often these are listed as middlings or screenings. These can include broken grains, hulls, chaff and joints, and can be contaminated with straw, dust, sand, dirt and weed seeds.

In less than 10 years we have seen two major recalls of pet foods because of mycotoxin contamination. Mycotoxins are fungi which grow when grains are stored in damp conditions. Many types of mycotoxins can cause serious illness and even death in both humans and pets.

**Pet owners
were shocked
that their
euthanised pets
could very well
be ending up in
pet foods.**

In 1995, Nature's Recipe pulled thousands of tins of dog food off the shelves after reports came in that dogs were vomiting and would lose their appetite after consuming the food. The fungus in this product was vomitoxin, caused by mouldy wheat used in the food. Although not a deadly toxin, it can cause serious illness in pets.

In late 1998, Doane Products, the manufacturer of a large number of private-label foods including Ol' Roy, recalled over 50 lines of foods it produces. The deaths of approximately 25 dogs were attributed to aflatoxin, a deadly toxin that was found in the corn Doane had used in its products.

We have to wonder how many other pets have become ill or died from eating contaminated pet food. If owners are unaware of other cases, they may never question the illness or death of a pet.

SODIUM PENTOBARBITAL RESIDUES IN PET FOOD

In the first edition of *Food Pets Die For*, I wrote about the studies undertaken by the University of Minnesota and the fact that its research showed that the euthanising drug, sodium pentobarbital, withstood the rendering process without degrading. This drug is used primarily to euthanise dogs and cats. Animals euthanised with this drug were ending up in pet foods, but no one could be sure from batch to batch how much of this drug was actually in the finished product.

In early 1999, while researching another aspect of the pet food industry, I came across a note in a report from the United States Animal Health Association (USAHA): "Over the years, the Center for Veterinary Medicine has received sporadic reports of tolerance to pentobarbital in dogs. In 1996, the CVM developed and validated a method to detect pentobarbital in dry dog food and a preliminary survey of 10 samples found low levels in 2 samples. CVM had collected 75 representative dry dog food samples and were in the process of analyzing these for pentobarbital levels."

At that point in time, testing had been ongoing for three years. It was clear from the onset that the FDA/CVM would not provide me with the test results. In May 2001, I filed a request under the Freedom of Information Act for all documentation relating to the testing of dry commercial dog foods. Again the waiting began, and again I enquired numerous times as to the status of my request.

In September 2001, I did receive a reply from the Office of Communications for the FDA: "We request you wait until the evaluation process is complete, at which time we will send the full results to you." They expected these to be ready in January 2002. It had been well over two years since I first requested the information, five years from the time they had begun testing these foods.

Finally, in early March 2002, the results were published. In the 74 samples analysed, over half contained residues of this drug at levels ranging up to 32.0 parts per billion (ppb). In an earlier study done in 1998, the FDA found other products containing this drug, although the amounts were not listed in its report. Results of both studies can be viewed at the FDA/CVM

website, <http://www.fda.gov/cvm/efoi/dfchart.htm>.

The FDA/CVM also undertook an assessment of the risk

dogs face if they ingest sodium pentobarbital in pet food. For eight weeks, an undisclosed number of dogs was given various levels of this drug, and it was found that: "Dogs who received 150 and 500 micrograms of pentobarbital once daily for eight weeks had statistically higher liver weights (relative to their body weights) than the animals in the control groups. Increased liver weights are associated with the increased production by the liver of cytochrome P450 enzymes." The report concluded that the levels of exposure to sodium pentobarbital which the animal might receive through food are "unlikely to cause them any adverse health effect". The FDA/CVM has admitted that if these levels—any levels for that matter—of sodium pentobarbital were found in human foods, those products would be pulled from the shelves immediately.

In a letter dated March 22, 2002, from Stephen Sundlof, Director of FDA's Center for Veterinary Medicine, regarding my query about this drug and the fact that under the Code of Federal Regulations it states, "Do not use in animals intended for food", he writes: "A euthanasia solution such as pentobarbital cannot have a withdrawal time and its mechanism of action results in tissue residue, so it could not be used to euthanize animals intended for human or animal food."

It is not allowed for use in either human or animal food, yet the FDA does not plan to take any steps to prevent or prohibit the presence of this drug in pet food.

Are we slowly killing our pets each time we feed them commercial pet foods?

Although the FDA/CVM tested a number of pet foods, we do not know if the food we are feeding our pets contains this drug; nor do we know what the long-term effects of ingesting this drug will be. Each batch of rendered material, meat meal, is different.

Are we slowly killing our pets each time we feed them commercial pet foods?

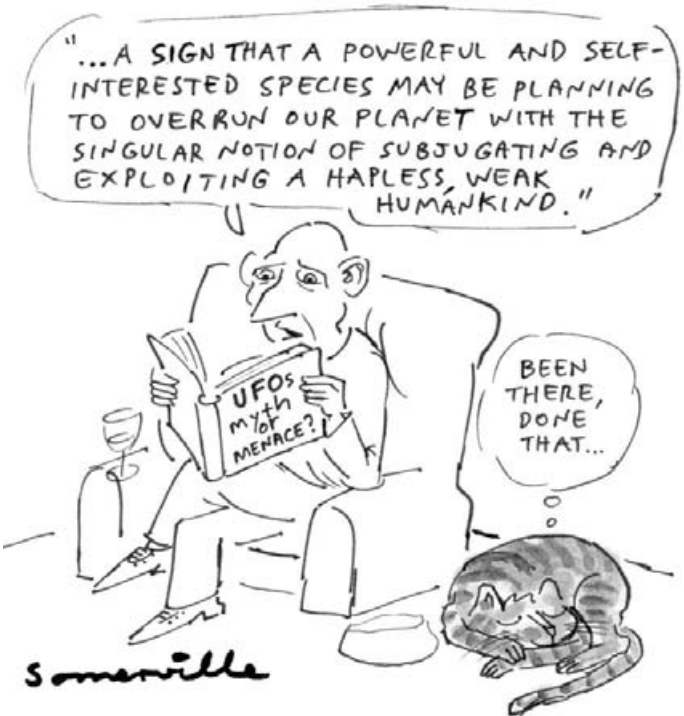

It depends on what animals they are rendering on that particular day and if they were euthanised, died in the field or were killed by another method.

In the last 10 years we have also seen a number of other species, primarily birds of prey, die from ingesting euthanised dogs and cats that have been buried at landfill sites. Sodium pentobarbital stays in the tissues of these animals for extended lengths of time. We have also seen bears and even a tiger die after eating animals euthanised with this drug.

It is clear that any animal that has been euthanised with sodium pentobarbital should be incinerated, not rendered and fed back to other animals.

DNA TESTING OF PET FOOD

The FDA/CVM also undertook DNA testing on the commercial dog foods they analysed. Results of the study were announced in January 2001, and the press release stated that no dog or cat DNA was detected: "Presently, it is assumed that the pentobarbital residues are entering pet foods from euthanized, rendered cattle or even horses."

In communications with agriculture veterinarians, most stated that sodium pentobarbital is seldom, if ever, used to euthanise cattle; its cost is "prohibitive". Cattle are killed by captive bolt and gunshot. Horses are sometimes killed with this euthanising agent but, again, unless for some specific reason, i.e., the horse is seriously injured at a racetrack, the methods used to kill cattle are also used on horses.

The DNA testing results were extremely vague and provided no insight into the methods used to conduct such testing. What it amounted to was: "Take our word for it. No dog and cat DNA was detected in the food we tested."

After I consulted with a number of forensic scientists, it became apparent that if indeed the FDA/CVM undertook such testing, the methods used would be extremely important. No information was given on the DNA primers. No information was provided regarding whether they tested for all the metabolites of pentobarbital. Rather than going the route of asking for the documentation related to the testing, I immediately filed a request under the Freedom of Information Act. This was on March 3, 2002.

The wait began, once again, and during that time I was sending emails to the department, enquiring into the status of my FOIA request. On December 20, I received what I had hoped was the information I'd requested, but what I was sent was actually a copy of a paper titled "Validation of a Polymerase Chain Reaction Method for the Detection of Rendered Bovine-Derived Materials in Feedstuffs". This was described as a document "similar" to what I'd requested. But had I wanted a similar report, I would have asked for such material.

On January 14, 2003, I contacted Steven Unger, Ombudsman for the Food and Drug Administration, and was advised by him that they would look into the matter. While I was out of the country in late January, Mr Unger wrote to advise me that my request had been denied by the FDA/CVM and that the denial had been mailed to me on January 22. From the time a request is denied, you have one month to file an appeal. On February 13, I still had

not received the denial. Finally, in desperation, I asked that they fax me the denial, which they reluctantly agreed to do. I might add that the mailed denial finally reached me in late April.

According to Dr Larkins, Ombudsman for the CVM, I was denied the report based on the fact that the information the CVM released was not the final report and was made up of "summary statements which were the written end-product of some oral briefings". In other words, the DNA information that the CVM released is not worth the paper it is written on.

With just days left to file an appeal, a lawyer for People for the Ethical Treatment of Animals (PETA) agreed to prepare the appeal. On February 15, I mailed, Priority Post, my appeal to the FOI office. Through a tracking system and communication with the Post Office, I found that by February 27 my document had not been received by the appropriate office. On February 28, the Freedom of Information officer informed me that it would be acceptable, given the problems I had encountered with the agency, to fax my appeal, which I did on that date.

It is clear that the FDA/CVM has been feeling the heat from the pet food industry with regard to the use of euthanised pets in commercial pet food. With its press release noting that no dog and cat DNA existed in the rendered dog foods, the agency felt that pet owners would no longer confront the industry with the fact that companion animals were being used as sources of protein in their products.

RESEARCH BY CORPORATIONS AND UNIVERSITIES

Having spent over 13 years researching this industry, I thought I was aware of all aspects as they relate to the ingredients used in pet foods. I was wrong!

In early January 2002, I received a letter from a student at the University of Illinois, asking if I could make some suggestions as to what they could do about nine dogs that were housed in a windowless lab at the university. These dogs had cannulas (tubes) surgically implanted in their sides so that samples of digested food could be taken. The studies included feeding the dogs raw and rendered animal by-products including "poultry necks and

backs and viscera, and ground-up poultry feathers". Until 2002, this research was funded by the Iams company, but now is being funded by the soybean industry and the US Department of Agriculture.

Over the years I've been aware of dogs and cats being used for research—research into human medicine, a practice of which I don't approve—but I'd never realised that an industry that claimed to care about the welfare of pets would undertake such barbaric practices. I was soon to learn that this was just the tip of the iceberg. Iams had been notorious for carrying on such experimentation.

Two animal rights organisations—In Defense of Animals, based in the United States, and Uncaged, based in the United Kingdom—outlined some of the animal experiments. Iams claimed that it used these studies to support its nutritional claims, which it uses to market its products.

Iams experimentation conducted on dogs and cats included the following:

Having spent over 13 years researching this industry, I thought I was aware of all aspects as they relate to the ingredients used in pet foods.

I was wrong!

1. Twenty-eight cats' bellies were cut to see the effect of feeding the cats fibre; then the cats were killed (University of Nebraska and the Iams Company; Bueno, A.R., et al., *Nutrition Research*, vol. 20, no. 9, pp. 1319-1328, 2000).

2. Twenty-four young dogs were intentionally put into kidney failure, subjected to invasive experimentation, then killed (University of Georgia and the Iams Company; White, J.V. et al., *American Journal of Veterinary Research*, vol. 52, no. 8, pp. 1357-1365, 1991).

3. The kidneys of 31 dogs were removed to increase the risk of kidney disease, then the dogs were killed and their kidneys dissected (University of Georgia and the Iams Company; Finco, D.R. et al., *American Journal of Veterinary Research*, vol. 55, no. 9, pp. 1282-1290, 1994).

4. Bones in the front and back legs of 18 dogs were cut out and stressed until they broke, to show the effect of diet (University of Wisconsin and the Iams Company; Crenshaw, T.D. et al., *Proceedings of 1998 Iams Nutrition Symposium*).

5. Ten dogs were killed to study the effect of fibre in diets (Mississippi State University and the Iams Company; Buddington, R.K. et al., *American Journal of Veterinary Research*, vol. 60, no. 3, pp. 354-358, 1999).

6. Eighteen male puppies' kidneys were chemically damaged; the puppies were fed experimental diets, tubes were inserted into their penises; then the puppies were killed (Colorado State University and the Iams Company; Grauer, G.F. et al., *American Journal of Veterinary Research*, vol. 57, no. 6, pp. 948-956, 1996).

7. Twenty-eight cats were surgically forced into kidney failure and either died during the experiment or were killed to study the effects of protein (University of Georgia and the Iams Company, *Proceedings of the 1998 Iams Nutrition Symposium*).

8. Fifteen dogs' bellies were cut open and tubes were attached to the dogs' intestines, the contents of which were pumped out every 10 minutes for two hours; then the dogs were killed (University of Nebraska-Lincoln and the Iams Company; Hallman, J.E. et al., *Nutrition Research*, vol. 16, no. 2, pp. 303-313, 1996).

9. Sixteen dogs' bellies were cut open and parts of the dogs' intestines were taken (University of Alberta and the Iams Company, *Journal of the American Society of Nutritional Sciences*, 1998).

10. Healthy puppies, chicks and rats had bone and cartilage removed to study bone and joint development (Purdue University and the Iams Company, *Proceedings of the 2000 Iams Nutrition Symposium*).

11. Invasive procedures were used to study bacteria in 16 dogs' intestines (Texas A&M University and the Iams Company; Willard MD, et al., *American Journal of Veterinary Research*, vol. 55, no. 5, May 1994).

12. Twenty-four cats had their female organs and parts of their livers removed; they were made obese, then were starved (University of Kentucky and the Iams Company; Ibrahim, W.H. et al., *American Journal of Veterinary Research*, vol. 61, no. 5, May 2000).

13. Fifty-six dogs had their female organs removed to study beta carotene (Washington State University and the Iams Company; Weng, B.C. et al., *Journal of Animal Science*, vol. 78, pp. 1284-1290, 2000).

14. Sixteen dogs' bellies were repeatedly cut to take parts of the intestines (Texas A&M and the Iams Company; Willard, M.D. et al., *Journal of the Veterinary Medical Association*, vol. 8, pp. 1201-1206, 1994).

15. Six dogs had tubes implanted into their intestines and fluid drained repeatedly to study cereal flours (University of Illinois and the Iams Company, Murray, S.M. et al., *Journal of Animal Science*, vol. 77, pp. 2180-2186, 1999).

16. Thirty dogs were intentionally wounded and patches of skin containing the wounds removed to study diet and the effect of various ingredients on wound healing (Auburn University and the Iams Company; Mooney, M.A. et al., *American Journal of Veterinary Research*, vol. 59, no. 7, pp. 859-863, 1998).

17. Five dogs' bellies were cut open and tubes inserted into their intestines to study the effect of fibre (University of Illinois and the Iams Company, Muir, H.E. et al., *Journal of Animal Science*, vol. 74, pp. 1641-1648, 1996).

18. Parts of the large intestines of 28 dogs were removed to study the effects of fibre (University of Missouri and the Iams Company; Howard, M.D. et al., *Journal of Animal Science*, vol. 75, suppl. 1, pp. 136, 1997).

19. Parts of the intestines and immune system of 16 dogs were cut out to study the effects of fibre (University of Alberta and the Iams Company, *Proceedings of the 1998 Iams Nutrition Symposium*).

20. Five dogs had tissue from large and small intestines removed to study intestinal tract needs (University of Illinois and the Iams Company, *Proceedings of the 1998 Iams Nutrition Symposium*).

Procter & Gamble (P&G) purchased Iams in September 1999 and issued a code of ethics. Animal People, an on-line organisation devoted to the health and welfare of pets, reported in June 2001 that P&G stated its intention to phase out animal testing as quickly as alternatives could be developed and approved by regulators.

In 2002, an investigator from PETA infiltrated one of the Iams labs in the US. What was found was a horrifying situation where dogs and cats were confined to small cages for up to six years. Dogs had their vocal cords removed so they could not bark. The animals suffered with severe heat in the summer and freezing temperatures in the winter. Videotapes showed researchers dumping dogs on concrete floors after having huge chunks of muscle cut out of their thighs. The cruelty continued. Cats were confined in cinder-block rooms with wooden boards, nails sticking out of them, as resting places. The PETA investigator watched as one of these boards fell on a cat, killing the animal.

Be assured that Iams is not the only company involved in such cruel research. Ralston Purina, prior to its acquisition by Nestlé, Hill's Pet Nutrition, owned by Colgate-Palmolive, Pedigree Pet Foods, owned by Mars, and Alpo Pet Foods, prior to its acquisition of Nestlé, are just a few of the companies involved in animal experimentation.

WARNING!

Do not read
the contents
of this page
if you have
just eaten!

PET FOOD: A GLOBAL CONCERN

The pet food industry worldwide is basically the same as that in the United States with little, if any, regulations regarding the ingredients used in its products.

And as with the situation in Canada, a vast percentage of the pet foods sold in other countries is imported from the United States.

• Australia

In Australia, the Pet Food Industry Association of Australia (PFIAA), a voluntary organisation, fills the same role as the Pet Food Institute in the United States, with a goal of promoting pet foods and setting standards for this self-regulated industry. Again, labelling text, not the source of ingredients, is the prime concern of this agency.

The other Australian agency involved with pet food, the National Registration Authority for Agriculture and Veterinary Chemicals, has as its "main role, with regard to pet foods, the registration of therapeutic claims associated with veterinary diets". Their role would not cover pet foods sold in supermarkets or feed stores; only pet diets that are sold through veterinary clinics and used for health-related problems. The NRA's role parallels that of the Center for Veterinary Medicine (CVM) in the USA.

In August 1997, the Australian Competition and Consumer Commission (ACCC) asked for a guideline review of pet foods after consumer complaints about the labelling of certain varieties of pet food being potentially misleading as to which protein was the main one. One example was a pet food which was essentially a meat product and was labelled as a fish product. During its investigation, the ACCC found that the labelling of other varieties of canned pet food was also potentially misleading and deceptive. It was agreed by the ACCC and the PFIAA that revisions to the labelling were needed.

• United Kingdom

In the United Kingdom, the organisation that oversees the pet food industry is also much like the Pet Food Institute in the United States. The Pet Food Manufacturers' Association (PFMA) represents approximately 95% of the UK pet food manufacturing industry and is comprised of 56 member companies. Their role is to promote pet food products and responsible pet ownership, represent their members' views to United Kingdom and European Union government departments and raise standards in the pet food industry.

If you believe PFMA's literature, then the policies in the United Kingdom are much stricter than those of other countries. "Member companies only use materials from animal species which are generally accepted in the human food chain," states Alison Walker, spokesperson for the PFMA. "This rules out the use of any materials from horses, ponies, whales and other sea mammals, kangaroos and many other species. The pet food industry only uses materials of beef, lamb, poultry and pork origin, fish, shellfish, rabbit and game."

The literature further states that PFMA members use only mate-

rial derived from animals that have been inspected and passed as fit for human consumption. Most of the material derived from these animals would be listed on the labels as meat by-products. I questioned the PFMA about the pet foods that are imported to the United Kingdom because of the dubious ingredients used in some of these products. Alison Walker of the PFMA replied to my inquiry, writing: "The import certification relates to materials specifically allowed in pet food—e.g., low-risk materials or, in other words, that [which] is fit for, but not intended for, human consumption." Ms Walker also advised that it is illegal to use dead companion animals in the manufacture of pet food in the United Kingdom and in most European countries. In the US and Canada, there are no regulations which prohibit this material from being used in commercial pet food.

The PFMA leaves it to the member companies to operate their own in-house quality assurance programs and feeding trials. Pet food manufacturers are also in charge of testing the incoming raw materials used in their products. Because of the number of cases of bovine spongiform encephalopathy (BSE) in the United Kingdom, and the number of cats that have died from the feline form of this disease (90 documented cases to date), certain materials derived from beef have been banned for use in pet food. This includes the head, spleen, thymus, tonsils, brain and spinal cord, and the large and small intestines of cows as well as sheep or goats. It is still legal to use pigs in pet foods because there have been no known cases of spongiform encephalopathy in these animals.

WHAT PET OWNERS CAN DO

As we have seen, the commercial food we are feeding our pets is generally garbage and, in my opinion, is unfit to feed to our pets. For the last 13 years, I have fed my pets a home-prepared diet comprised of lightly cooked meat or fish, grains and fresh vegetables and fruit. All of them, including my 27-year-old cat, have done extremely well.

The only way we will see a change in this industry is for pet owners to boycott pet foods that contain inferior ingredients, including drugs which would never be allowed in the human food chain. We must also boycott companies that undertake experiments

on animals—not only on dogs and cats but on *all* animals. It is apparent that the only reason these experiments are undertaken is to ascertain the cheapest, most viable sources of protein, grains and fats that can be used in pet foods.

It is you and I who will make a difference. ∞

About the Author:

Ann Martin is the author of *Protect Your Pet* (NewSage Press, 2001) and *Food Pets Die For* (NewSage Press, 1997, 2nd edition 2003). For more information, visit the web page <http://www.newsagepress.com/foodpetsdiefor.html#author>. To order Ann Martin's books, contact NewSage Press by telephone on 877 695 2211 (toll free in North America only), by email at info@newsagepress.com, or via <http://www.newsagepress.com> or Amazon.com.

**The only way
we will see a change
in this industry
is for pet owners
to boycott pet foods
that contain
inferior ingredients,
including drugs.**

THE NEW MEDICINE OF DR HAMER

Dr Ryke Geerd Hamer has discovered the shock-conflict mechanism underlying cancer development, but has been persecuted by German and other European courts for his theory and successful treatments.

by Walter Last © 2003

Website:
<http://www.mrbean.net.au/~wlast>

The German doctor Ryke Geerd Hamer (b. 1935) has had an exceptionally high success rate with his cancer therapy—by far the highest I have seen of any therapy. During one of several trials of the much-persecuted Dr Hamer, the public prosecutor (in Wiener Neustadt, Austria) had to admit that 6,000 out of 6,500 patients with mostly advanced cancer were still alive four to five years after Dr Hamer's treatment. That is a success rate of over 90%—almost a reversal of the results to be expected after conventional treatment of advanced conditions.

Dr Hamer developed testicular cancer soon after his son was shot dead in 1978, and wondered whether his son's death was the cause of his cancer. However, it wasn't until three years later, when he worked in a cancer hospital at the University of Munich, that Dr Hamer was able to start his cancer research in earnest. Subsequently, he investigated and documented 15,000 cases of cancer and always found the following characteristics to be present, which he termed the Iron Rules of Cancer.

THE IRON RULES OF CANCER

1. Every cancer and related disease starts as a DHS—a Dirk Hamer Syndrome (named after his son). This is a serious, acute-dramatic and isolating conflict-shock experience. It manifests simultaneously on three levels: psyche, brain and organ.

2. The theme of the psychic conflict determines the location of the focus or Hamer Herd in the brain, and the location of the cancer in the organ.

3. The course of the psychic conflict correlates with the development of the Hamer Herd in the brain, and the course of the cancer in the organ.

At the moment of the conflict-shock, something like a short circuit occurs in a pre-determined place of the brain. This can be photographed with computed tomography (CT), and looks like concentric rings on a shooting target or like the surface of water after a stone has been dropped into it. Later on, if the conflict becomes resolved, the CT image changes as an oedema develops and, finally, scar tissue.

How specific and precisely located these brain lesions are may be seen from the following example. After a professional lecture, a doctor handed Dr Hamer the brain CT of a patient and asked him to explain it. From this, Dr Hamer diagnosed the patient as having a fresh bleeding bladder carcinoma in the healing phase, an old prostate carcinoma, diabetes, an old lung carcinoma and sensory paralysis in a specific area, in addition to the corresponding emotional conflicts.

Amazingly, Dr Hamer has been able to show that at the same time as the concentric brain lesion appears, the target organ CT may also show such a concentric lesion. According to Dr Hamer, this happens instantly when the psychic shock hits the subconscious level, and this same second is the start of cancer. However, other diseases can also be caused by the same mechanism. How severe a disease becomes may depend on other psychological, energetic and nutritional factors, but its nature and location are determined by the content of the conflict shock.

Dr Hamer believes that the correlation between key emotional shock events, the target brain areas and the related organs has developed as a human evolutionary adaptation from similar programs in the animal world. When we unexpectedly experience emotional distress, an emergency repair program is set in motion—a biological conflict program—with the aim of returning the individual to normal. Such

programs can even apply to families or other groups.

Dr Hamer gives the following example. A mother sees her child having a bad accident. In evolutionary terms, infants recover faster when they receive extra milk. Therefore, the mother's biological conflict program tries to stimulate milk production by increasing the number of breast cells. If the mother is right-handed, that will instantly cause the appearance of a Hamer Herd in a specific part of her right brain, which in turn relates to the left breast. When the child is well again, conflict resolution begins and extra milk is no longer needed. The mother gets a benign form of tuberculosis in that breast, which then breaks up the excess breast cells. However, if the mycobacteria required for this are lacking, then the area may just calcify and remain as a dormant tumour.

The same process applies also to animals. A sheep that loses its lamb to a wolf is prone to develop teat cancer; the side depends on whether it is right or left footed. However, the sheep commonly resolves this conflict by bearing another lamb.

The following example may illustrate the original survival value of this mechanism. Let's assume a lion chases an antelope. The antelope must immediately mobilise all its resources to survive. The sympathetic nervous system takes

over and, in addition, a specific brain centre becomes active that stimulates lung activity. After the successful escape, the animal rests and the parasympathetic nervous system becomes dominant for a while to normalise body functions.

If, instead, a person is given a cancer diagnosis, even if the diagnosis is wrong, the same biological program is set in motion by the same fear of death that helped the animal to escape. The stress level jumps and the brain/lung connection is activated, but now there is nowhere to run. Until the conflict is resolved, which may take years, there will be constant stress as well as brain-induced stimulation of lung activity, which now takes the form of increasing lung capacity by the incessant division of cells.

This process can only be stopped by switching off the trigger in the brain through defusing the original conflict-shock. This happens when the patient subsequently has surgery or natural therapy which he or she fully believes will lead to a cure. However, the same procedure in a patient who has doubts about its effectiveness will leave the conflict unresolved and the disease to progress. Thanks to Dr Hamer's work, this is no longer just an unsubstantiated assumption but, rather, scientific fact that can be verified anytime with a CT brain scan.

The selection of the conflict focus occurs by subconscious

The following list shows some of the relationships between conflict emotions and target organs:

Adrenal cortex – wrong direction, gone astray;
Bladder – ugly conflict, dirty tricks;
Bone – lack of self-worth, inferiority feeling;
Breast milk gland – involving care or disharmony;
Breast milk duct – separation conflict;
Breast, left (right-handed) – conflict concerning child, home or mother;
Breast, right (right-handed) – conflict with partner or others;
Bronchials – territorial conflict;
Cervix – severe frustration;
Colon – ugly, indigestible conflict;
Gall Bladder – rivalry conflict;
Heart – perpetual conflict;
Intestines – indigestible chunk of anger;
Kidneys – not wanting to live; water or fluid conflict;
Larynx – conflict of fear and fright;
Liver – fear of starvation;
Lung – fear of dying or suffocation, including fear for someone else;
Lymph glands – loss of self-worth associated with the location;
Melanoma – feeling dirty, soiled, defiled;
Middle ear – not being able to get some vital information;
Mouth – cannot chew or hold it;
Oesophagus – cannot have/swallow it;

Pancreas – anxiety-anger conflict with family members, inheritance;
Prostate – ugly conflict with sexual connections or connotations;
Rectum – fear of being useless;
Skin – loss of integrity;
Spleen – shock of being physically or emotionally wounded;
Stomach – indigestible anger, swallowed too much;
Testes and Ovaries – loss conflict;
Thyroid – feeling powerless;
Uterus – sexual conflict.

These are some other specific diseases which are related to conflict emotions:

AIDS – Dr Hamer observes that no one ever died of AIDS without having previously been told that they are HIV positive or believe that they are. The implication is that, just as with cancer, it is the negative perception associated with AIDS that causes its devastating effect.
Angina pectoris – Caused by territorial conflict in the active phase, and heart infarct in the healing phase.
Diabetes and hypoglycaemia – A right-handed female develops hypoglycaemia from anxiety and revulsion, but if left-handed she develops insulin-dependent diabetes. A right-handed male develops insulin-dependent diabetes from a conflict of resisting or struggling against something, but if left-handed he develops hypoglycaemia.
Facial paralysis – Fear of losing face,

having been made a laughing stock.
Haemorrhoids – A right-handed woman with an identity conflict and a left-handed man with territorial anger in the healing phase will get haemorrhoids.
Heart infarct – Fight for territory or its content.
Multiple sclerosis and paralysis – Inability to escape, continue on or to hold onto, or not knowing what to do.
Psoriasis – Involves separation conflict concerning mother, father, family, home, friends or pets.
Psychoses of all kinds have one or more active Hamer Herds in each of the two parts of the brain.
Rheumatism – A brutal separation conflict causing pain or suffering.
Vitiligo, Leukoderma – An ugly or brutal separation conflict.

A note on handedness:

Left-handed individuals develop problems on opposite sides to genuine right-handed individuals. Handedness can be tested by observing which hand is on top when clapping; this is the leading hand. With right-handedness, all muscles on the right side of the body are involved with partners and possibly other individuals, and all left-sided muscles with children or their own mother.

These conditions may change with hormonal changes, as with use of the birth control pill or with menopause.

association. For instance, biological conflicts involving water but also other fluids, such as milk or oil, lead to kidney cancer; fear of death leads to lung cancer; and psychologically swallowing a bigger chunk than we can digest leads to stomach or intestinal cancer. Originally, in the animal world, it really was a big chunk of food, but for us it may be a financial overcommitment or any other obligation that we have taken on and cannot fulfill. However, the target focus is not determined by the event itself, but, rather, by the psychological significance that it has for us at the time of the event.

Dr Hamer illustrates this with the example of a woman who finds her husband in bed with another female. As a sexual frustration conflict, it causes uterine cancer. If she instead experiences it as a partner conflict, then in a right-handed woman it leads to cancer of the right breast. If the conflict feeling is fear and revulsion, then it causes hypoglycaemia. With lack of self-worth, cancer may develop in the pubic bone. If the lack of self-worth was due to a failure in sportsmanship rather than being sexually related, then the problem would have arisen in an arm or leg instead or possibly in the fingers or shoulder. Other typical situations that may lead to biological conflicts are loss situations: loss of a loved one, a job, a valued possession or a territory.

Dr Hamer believes that most metastases or secondary tumours are caused by the cancer-fear or death-fear resulting from the patient being given the cancer diagnosis or a negative prognosis. However, also in this case, the resulting conflict-shock may not be fear of death but rather anger, resentment or a separation conflict from partner or children, and then tumours would appear in different places. Also, a diagnosis of colon cancer commonly leads to liver cancer because of a subconscious fear of starvation.

Generally, hopelessness, despair and meaninglessness create chronic stress, which prevents the healing from cancer and other diseases, but they are not the cause of the diseases. According to Dr Hamer, the real cause of cancer and other diseases is an unexpected traumatic shock for which we are emotionally unprepared.

THE HEALING PHASE

The start of a DHS or conflict-shock experience is different from other conflicts that we experience in our daily lives. It causes a continuous stress resulting in a tendency to develop cold hands and feet, lack of appetite and weight loss, sleeplessness and dwelling all the time on the conflict content. If the conflict does not become resolved soon, the long-lasting stress will lead to specific symptoms and the development of cancer or another disease.

When the conflict resolves, the patient is no longer occupied with the conflict content, the appetite returns, hands are warm again and also normal sleep returns, but there may also be weakness, fatigue and a need to rest. These effects show that the parasympathetic nervous system is now in control.

This is the beginning of the healing phase, which can be long and difficult.

During the first part of the healing phase, there are water retentions and inflammations but the tumour stops growing. This eventually leads to a healing crisis, which Hamer calls an *epileptic* or *epileptoid* crisis because it is caused by an oedema in the Hamer Herd brain lesion. It shows unique symptoms for each illness.

After this, the body starts to expel the accumulated water, the patient gradually regains strength and the body functions become normal. Now the brain's connective tissue, the glia, starts repairing the Hamer Herd. This may be interpreted by conventional radiologists as a fast-growing brain tumour and treated accordingly.

Dr Hamer estimates that 99% of brain events, such as strokes, bleeding into the brain, cysts and tumours, are due to healing events of Hamer Herds. Therefore, he regards them as temporary and self-limiting, unless there is inappropriate medical intervention. The most important support in these situations is the reduction of any brain oedema.

During the healing crisis, the patient may for a short time re-experience the original psychological conflict with cold hands and cold sweat. This serves to suppress and eliminate the oedema in the brain lesion, which then allows other body conditions to normalise. The main danger point is just before the end of the healing crisis when it will become apparent if the body is strong enough to eliminate the disease.

In difficult cases with long or strong conflict duration, massive brain oedema may develop, for which Dr Hamer uses cortisone injections. In natural therapy, we use an assortment of urea and anti-inflammatory therapies instead.

Urea has strong diuretic properties and an excellent effect in cases of dangerously high fluid pressure in the brain. Generally, 20 grams of urea are used 2 to 5 times daily.

One life-threatening case has been described of a massive brain tumour re-growth that completely disappeared within two hours after the patient received 256 mL of 30% urea, as described in *Your Own Perfect Medicine* by Martha Christy (FutureMed, Inc., USA). This report clearly shows that the presumed brain tumour in fact was a massive oedema, as postulated in the New Medicine.

What Dr Hamer calls the epilepsy crisis may be experienced by the patient as a heart attack, lung embolism, hepatitis or a lung infection. Generally, during the healing phase, the patient will have more discomfort than when the tumour was actively growing.

In the first part of the healing phase, when the body releases inflammatory hormones, most problems are due to water retention, inflammation and swelling of tissues, all of which can cause a lot of pain. Hamer regards oedema, whether found in the brain or in an organ, as positive—a sign of healing.

**According to
Dr Hamer, the real
cause of cancer and
other diseases is an
unexpected
traumatic shock
for which we are
emotionally
unprepared.**

TISSUE REPAIR

After the healing crisis, adeno-carcinomas are removed by fungi and mycobacteria while hepatitis virus may in addition help to regenerate the liver. At this stage, bacteria, viruses and fungi that help to break down the tumours and repair damaged tissues also cause inflammation, pain and fever.

If you find it odd that Dr Hamer regards microbes as essential friends and helpers in the healing of cancer, he has made an even more surprising discovery. In his ontogenetic system of tumours and cancer-equivalent diseases, he distinguishes between two opposite processes during the active conflict phase.

Depending on the location of the Hamer Herd in the brain, there may be either cell proliferation or cell destruction. The first group has cell proliferation and tumour growth during the conflict phase and then removes excess cells with the help of microbes during the healing phase. The other group causes cell destruction during the conflict phase, resulting in ulcers, necroses and tissue holes affecting, for instance, bones (osteoporosis), kidneys, spleen or ovaries. During the healing phase, this second group tries to fill in the holes created through cell proliferation. Tissue necroses and osteolyses (dissolved bone) are now repaired by bacteria that first form abscesses, which are then filled in with scar tissue and later with granulating tissue to form osteosarcoma, lymphoma, fibroma and healing cysts. Also, leukaemia commonly occurs during the healing phase, as it does after bone marrow damage from radiation, chemicals or bone cancer.

According to Dr Hamer, these conditions are generally self-limiting and only get out of control when additional conflict shocks occur, or when the body is too old or weak, or through the methods of conventional medicine. In contrast, natural healing methods aim to support body and mind during this trying time. Most healings proceed without major problems, but about 10% need the full support of an experienced therapist, especially at the time of the healing crisis.

HEALING THE PSYCHIC CONFLICT

The main task in every case of cancer is to find the original emotional shock experience and make sure that it has been healed or is being healed. In many cases it will have corrected itself, and the patient suffers from an effect of the healing phase. For instance, someone may have lost a farm or business but has now started another satisfying venture or hobby. As an after-effect, there may now be a tumour that gradually becomes dormant or eventually disintegrates. About 40% of tumours discovered during routine medical investigations are said to be old and harmless; that is, dormant and calcified. However, complications may still arise if medical intervention then instills a fear-of-death conflict-shock that induces the same or another tumour to grow.

Nevertheless, in other cases the original conflict may still be active or there may be a second active conflict. As we do not know, we have to probe in every case to find the original and any other conflicts. We need to think back, especially one to

two years before our problem started, and analyse our emotional history during this time as well as before and after. Also, meditation or regression therapy may be useful to discover conflict shocks.

If we still have a strong emotional response when we discover the content of the conflict, then we can be sure that it is still unresolved. If possible, it is best to solve it in a natural way. For instance, if it was caused by losing a partner, then you could find someone new; if you lost a child, you could become pregnant again (cancer does not continue to grow after the third month, as pregnancy has priority) or adopt a child. However, it is not the fact of being pregnant or having a new partner or pet that heals but, rather, having the possibility of coming to terms with our loss, accepting it and getting on with life. Whoever cannot do this will not benefit from having a new partner/child/pet, but a good therapist may still find it easier to help that person.

If a natural solution is not possible or if you don't have access to a therapist, then use guided imagery either on your own or with the help of a partner or close friend. In a relaxed and meditative state, re-create and re-experience the conflict

The main task in every case of cancer is to find the original emotional shock experience and make sure that it has been healed or is being healed.

as intensely as you can, but then substitute a desirable or acceptable outcome. Create and experience this new outcome as vividly and detailed as possible; see it, feel it, and possibly even hear and smell it. The original experience may also have imprinted you with the memories of unrelated details (tracks) of your ordeal, to which you may now react with allergies. You may try to overcome these in the same way with guided imagery.

If neither of these methods is possible because you feel that you have to continue your present

duties or ordeal for whatever reason, then only increased spiritual understanding and acceptance may be able to help. In either case, be aware of your vulnerabilities and avoid any further conflict-shocks—but if one does happen, get it out of your system as soon as possible.

In addition, I firmly believe that all active conflicts will be terminated and the healing phase will begin when we are able to feel love and forgiveness strongly within ourselves and then radiate it to all others, but especially to anyone we feel may have wronged us. We can further ease the healing phase by expecting it to be short and mild and lead to full recovery.

According to Dr Hamer, animals in the wild get cancer from the same shock programs as we do. However, 80–90% survive and do not notice much because the healing phase can take its natural course. Those that die are mainly old animals that cannot resolve a conflict, such as regaining their territory from a rival or replacing a lost cub.

It is different in our society, as the natural healing process is routinely interfered with. It starts with getting tranquillisers or antidepressants during the active conflict phase, which prevent us from fighting back and regaining our territory. This may then lead to a cancer diagnosis that causes an additional active conflict and may end with the prescription of morphine, which totally disables our healing responses.

While Dr Hamer does not believe that health foods, remedies, cleansing or healthy living in general can cure cancer,

these certainly can be important in order to survive the ordeals of the healing phase.

Actually, Dr Hamer regards all diseases as consisting of two phases: initially with active conflict, followed (if possible) by a healing phase that reverses the conflict program. He does not call them diseases any more but, rather, *special biological programs*. He is stated to have worked with over 31,000 patients and found his theories confirmed in every single case without exception. He claims that, overall, the New Medicine has a 95% success rate in reversing cancer under ideal conditions, e.g., early resolution of the conflict, no new conflict and no interference from conventional medicine. However, many patients with advanced conditions may not be able to resolve their conflicts, or do so only too late, and thus fail to respond to treatment.

THE PERSECUTION OF DR HAMER

Siemens, manufacturer of the CT equipment, has independently verified the existence of the Hamer Herds in the brain. Furthermore, in 1998 the University of Trnava in Slovakia confirmed the diagnostic significance of the Hamer Herds. Nevertheless, Dr Hamer has faced exceptional persecution.

Under German law, a licence to practise medicine can be withdrawn if the doctor has diminished mental abilities. This law was used in 1986 by a German district court to withdraw Dr Hamer's licence to practise. As proof of Dr Hamer's supposedly inadequate mental condition, the court stated that he was not willing to retract his theories and swear allegiance to the principles of orthodox medicine.

Even worse, the court discovered evidence that he was incapable of converting to the principles of orthodox medicine: he had tried to convince a group of prominent professors of the correctness of his theories only one month before the court case! One year later, the same court requested a psychiatric assessment of his mental abilities, which Dr Hamer refused. Without ever seeing him, a court-appointed psychiatrist diagnosed Dr Hamer as being a psychopath!

In 1997, Dr Hamer was arrested and jailed for 18 months under an obscure natural therapy law introduced under Adolf Hitler to suppress the Gypsies. His crime was that he had given free health advice to some individuals who had asked him for his opinion. The public prosecutor openly stated that all means must be used to remove Dr Hamer from society. Compare this to a 13-year delay of the trial of his son's killer and then a sentence of only six months on probation. This mild sentence may have had something to do with the accused being the Prince of Savoy, the son of the last king of Italy.

Since 1999, Dr Hamer has lived in Spain because courts in Germany, Austria, France and Switzerland now want to try him because some cancer patients died supposedly as a result of following his advice. According to this reasoning, Dr Hamer is a mass murderer because he denied cancer patients

the supposedly safe and effective treatment offered by orthodox medicine.

Furthermore, a public prosecutor initiated a civil action against Dr Hamer for a large sum of money because he had advised a patient against having chemotherapy. In another instance, the parents of a little girl, Olivia Pilhar, who had been treated by Dr Hamer, received an eight-month suspended jail sentence for temporarily evading chemotherapy treatment for their daughter and after the girl had finally been removed from their custody and treated against their will. This can happen anywhere in the Western world. In Australia, a mother recently told me that while she did not believe in chemotherapy and would prefer natural therapy for her daughter with leukaemia, she had to go along with it because the treating doctor threatened to take her to court if she refused.

There is no cancer therapist in the world who has not had patients die under their care. However, even with advanced cases, Dr Hamer's success rate is exceptionally high. This witch-hunt has been compared to the fate of Dr Semmelweis, who suggested that surgeons wash their hands before operations and was sent to a mental asylum where he died aged forty-seven.

Dr Hamer has survived eight assassination attempts, and the mass media in Germany treat him as a deranged criminal. While many individual doctors, including professors of medicine, have verified the principles of the New Medicine, so far no German university has agreed to test them, despite a court order that the University of Tübingen conduct such tests.

Furthermore, doctors and natural therapists in Europe who practise according to the principles of the New Medicine face persecution. In Austria, Belgium, France, Germany and Spain, authorities have started proceedings against such doctors to take away their right to practise. Court cases have been going on for years. Only the courts in Spain have

adopted the enlightened position that it is not their role to decide between conflicting medical theories and therapies.

The vicious response of the Establishment is understandable because widespread knowledge and application of the New Medicine would mean the end of the medical-pharmaceutical complex.

However, in 2001 a prominent neurologist openly defended Dr Hamer by publishing a book about the New Medicine and demanding that his theories be tested officially. Because Dr Therese von Schwarzenberg also belongs to the high nobility, the mass media are in a bind as to what position to take on this. Until now, they have only reported about Dr Hamer in the most derogatory ways, and now there's a high-profile personality who claims that Dr Hamer is right and deserves a Nobel Prize!

Nevertheless, the official response of prominent oncologists still remains that it is totally absurd to assume emotions could be important in the cause and cure of cancer and, therefore, Dr Hamer's claims must not be tested.

In 1997, Dr Hamer was arrested and jailed for 18 months under an obscure natural therapy law introduced under Adolf Hitler to suppress the Gypsies.

REFLECTIONS ON DR HAMER'S DISCOVERIES

My own understanding and experience leave no doubt about the primary importance of our emotions and beliefs in the cause and cure of our diseases. Furthermore, the writings of Dr Hamer give the impression of a serious and meticulous researcher whose findings have been confirmed by various scientific institutions and medical practitioners, including professors of medicine. Only those who refuse to look at his evidence continue to denounce him.

Therefore, I have no doubt about the validity of his basic premise: namely, that specific diseases, in particular cancers, are associated with visible lesions in specific locations of the brain as well as specific psychological experiences. His postulated two-part disease process, in which the healing phase is a reversal of the original disease conditions, is a basic concept of natural therapies.

However, Dr Hamer appears reluctant to consider extending or modifying his theory to take other possibilities into account. Basically, he postulates a one-way communication from psyche to organ via the brain. I suggest, instead, a two-way communication from psyche to organ as well as from organ back to brain and psyche.

I like to explain this by way of an example. I understand that the death rate from breast cancer in China is one in 10,000 compared to about one in 10 in most Western countries. Professor Jane Plant realised that unlike Western and Westernised women, the Chinese do not use animal milk or related products. At this stage, she was going through the fifth occurrence of breast cancer and had been given up to die. So she decided to avoid all milk products, and soon after this her tumour disappeared. She has now been free of cancer for 13 years (see *Your Life in Your Hands* by Jane Plant, published by Virgin, UK, 2000).

As the Chinese have normal rates of some other cancers, there needs to be a special factor that causes these low breast cancer rates. Assuming that it really is milk, I would apply the following reasoning.

Milk is high in insulin growth factor, IGF-1, which stimulates breast tissue to grow during puberty and pregnancy. IGF-1 is also present in the flesh of dairy cows and apparently also stimulates other hormone-related cancers, including prostate cancer. Assuming that this causes constant low-level stimulation of breast tissue and the related brain area in milk-drinking or dairy-consuming women, there are now two possibilities.

1. The sensitised brain areas will cause the woman to have a much stronger emotional response than normal to any child or partner conflict, and this causes milk-drinking women to develop more frequent breast cancers.

2. The second possibility is an existing sub-acute conflict situation or past event that is still subconsciously active. The persistent combined stimulation due to a sub-acute conflict in

However, a surprising finding was the direct involvement of the brain. When a radioactive nutrient was placed in the back of the mouth, within seconds the isotope was also detected in the brain.

addition to IGF-1 may cause the *gradual* development of a Hamer Herd or, alternatively, its sudden appearance when a certain threshold is reached.

In this way, any environmental factors can be taken into consideration for creating Hamer Herds in combination with psychological conflicts.

Most people presently have a very unhealthy lifestyle in addition to a poor quality of inherited genes. It may well be that really healthy individuals will not develop a Hamer Herd in response to an unexpected emotional shock, or that it will be a mild and self-healing event.

In a similar way, appropriate natural therapy, directed to a diseased organ, may give a message to the associated brain area that helps healing the Hamer Herd and in time also leads to a resolution of the emotional conflict.

A confirmation of the suggested interconnectedness

between emotions, nutrients, brain and organs can be found in kinesiology. Research in muscle testing has revealed a relationship between different nutrients and emotions with specific muscles and organs, transmitted through the system of acupuncture meridians.

However, a surprising finding was the direct involvement of the brain. When a radioactive nutrient was placed in the back of the mouth, within seconds the isotope was also detected in the brain.

I suggest that conflict resolution may also happen in non-specific ways. Assuming a patient receives a conflict-shock due to a diagnosis of cancer, then this conflict and possibly also the original conflict-shock may be resolved if the patient fully believes and expects that the subsequent treatment will be a cure. Other possibilities have been suggested under the previous subheading, *Healing the Psychic Conflict*.

Dr Hamer's official English-language website is at <http://www.newmedicine.ca>. However, much more information is available on the German website, <http://www.pilhar.com>, which also has a limited

English-language section. Dr Hamer has written several books, one of which is available in English under the title, *Summary of the New Medicine*. ∞

About the Author:

Walter Last worked as a biochemist and research chemist in the medical departments of several German universities and at Bio-Science Laboratories in Los Angeles, USA, and later as a nutritionist and natural therapist in New Zealand and Australia.

He has written numerous health-related journal articles as well as several books, including *Heal Yourself and Healing Foods* (Penguin Books). His next book, *The Natural Way to Heal*, is to be published in late 2003 by Hampton Roads Publishing. Walter Last's website, covering issues concerning health, science and spirituality, is at <http://www.mrbean.net.au/~wlast>.

Rockefeller Globalism

**Philanthropist,
plutocrat and
former banker
David Rockefeller
has been promoting
his "one world"
vision among global
powerbrokers since
the 1960s, while
dismissing claims
that he's part of a
cabal out to control
the planet.**

Part 3

by Will Banyan

© May 2003

Email:
banyan007@rediffmail.com

THE "PROUD INTERNATIONALIST": DAVID ROCKEFELLER (1915 –)

Most analysis of the role of David Rockefeller in the New World Order is usually ridiculed by smug commentators in the "responsible" press as the stuff of fantasy. For these oracles, descriptions of Rockefeller as "one of the foremost partisans of world government under the UN" (Jasper), the "éminence grise of international power politics" (Wilkes) and "one of the most high profile, and most obvious, New World Order manipulators on the planet" (Icke)¹ are not to be taken seriously. Indeed, to contend that the billionaire ex-banker, philanthropist and founder of the Trilateral Commission could have any global designs is taken as a sign that one has fallen for the infantile ravings of the "black helicopter crowd". Perhaps, it is implied, only those afflicted by a peculiar mental malady could believe or contemplate such claims.

Back in 1996, for example, high-rating US national radio talk-show host Rush Limbaugh openly mocked these beliefs in his so-called "Kook Test":

- *Do you believe that David Rockefeller, Henry Kissinger and other famous members of the New World Order provide daily instructions to agents of the FBI, CIA, BATF, and National Organization of Women?*
- *Do you believe that the feminist movement was the brainchild of David Rockefeller for the purpose of having men and women at war with each other on a daily basis so as to distract them from the real conspiracy of the CFR?*
- *If you have answered even one of these questions "yes", then you are a kook and have passed the test.*

David Rockefeller himself has often scoffed at such claims. In a letter to the *New York Times* in 1980, he took issue with the "nonsensical defamation" he claimed to have been subjected to over the years. "I never cease to be amazed by those few among us who spot a conspiracy under every rock, a cabal in every corner..." David wrote, lamenting that he was usually "singled out as the 'cabalist-in-chief'". Eighteen years later, David's mirth remained intact. "It's so absurd I can't help but, to some extent, find it amusing", he told the *Pittsburgh Post-Gazette* in 1998, commenting on conspiracy theories about himself and the Trilateral Commission.²

Yet curiously, David's key role in promoting global political and economic unity is not only explicitly recognised but is openly celebrated within the power-elite. According to one recent tribute, because of his "contributions to enterprise and humanity" David had become "one of the world's most respected citizens". The speaker, Thomas d'Aquino, President and CEO of the Canadian Council of Chief Executives, addressing an elite gathering in 2002, had no qualms praising David's "impressible urge to promote international cooperation and understanding" and his "passions...for the promotion of international cooperation" and "inter-American cooperation".³ Equally unrestrained was Harvard University President Neil Rudenstine, who venerated David in 1999 as an "informed, observant, experienced, modest, and generous citizen of the world, interested in the welfare of all".⁴

At celebrations for the 25th anniversary of the Trilateral Commission's US group in 1998, a roster of adoring Establishment heavyweights repeatedly toasted the "sense of vision" (Berthoin), "farsightedness and leadership" (Ogata), "great munificence" (Black) and "sense of obligation" (Kissinger) of their Honorary Chairman. The "first global history of mankind is about to start", claimed Georges Berthoin, a former European

Chairman of the Trilateral Commission, and it was all due to David Rockefeller, the "gentleman-pioneer of the trilateral world".⁵ Similarly, at a book signing for David's new autobiography, *Memoirs*, held in late 2002 at the United Nations headquarters in New York, UN Secretary-General Kofi Annan hailed the plutocrat's contribution to world order:

*I think without internationalists like you, the international system we have been trying to build, the international system we have today, wouldn't be here. So, thank you very much, David.*⁶

But we need not take their word for it. After years of denying and ridiculing such charges, David Rockefeller has finally put an end to the speculation, making the following admission in *Memoirs*:

*For more than a century, ideological extremists at either end of the political spectrum have seized upon well-publicized incidents...to attack the Rockefeller family for the inordinate influence they claim we wield over American political and economic institutions. Some even believe we are part of a secret cabal working against the best interests of the United States, characterizing my family and me as "internationalists" and of conspiring with others around the world to build a more integrated global political and economic structure—one world, if you will. If that's the charge, I stand guilty, and I am proud of it.*⁷

David Rockefeller's bold confession, finally given late in his life, is clearly momentous but it also warrants further scrutiny, for his account in *Memoirs* omits much important detail. Only by examining David's statements, articles and speeches over the past 40 years can the true extent of his vision of "a more integrated global political and economic structure" be understood. And such examination also reveals that David has not been an idle dreamer, but has used his position as arguably the most powerful and influential Rockefeller of the latter half of the 20th century to advocate a revamped version of the Wilson–Fosdick world order model.

The Heir Apparent

One of the more common observations made by biographers of the Rockefeller family is that of all John D. Rockefeller, Jr's offspring, it is David, despite being the youngest, who has emerged as the true heir to the vast reservoir of political and economic power originally amassed by John D. Rockefeller, Sr. As Peter Collier and David Horowitz observe in their book, *The Rockefellers*, in contrast to his siblings it was David who "was the most serious, the one who was conscious of his birthright from the beginning".⁸ Even Senior seemed to sense that his genes had finally re-emerged under David, and he doted on his youngest grandson with a degree of affection he had not given to his own son.

Coincidentally, David recalls in *Memoirs* that it was in 1937, at the funeral service for Senior (who died at the age of 97), that he learned not only that was he the deceased monopolist's "favorite" but that Senior had "always thought" David was "most like him[self]". Having received this confirmation of his status from

Senior's trusted valet of some 30 years, John Yordi, David admits to having been ecstatic: "I thought it would have been Nelson, but *I couldn't pretend I wasn't pleased*."⁹ It is noteworthy that David starts *Memoirs* with this incident, as it is one of the few admissions to his true status.

Lacking Nelson's hunger for publicity and overt power, David's career path took a somewhat different course. Educated at Harvard, the London School of Economics (LSE) and the University of Chicago, David became the only one of Junior's children to have earned a PhD. The subject of his dissertation, essentially an attack on government regulation of business activity, was "Unused Resources and Economic Waste" (1940). Upon completion of his studies, and contemplating a career in politics, David returned to New York in 1940 to work as secretary to New York Mayor Fiorello La Guardia. In mid-1941, tiring of local politics and seeking "administrative experience", David started work with a new government body, the Office of Defense, Health, and Welfare Services. This proved to be short-lived, though, and with the outbreak of the war David enlisted in the US Army, going on to serve as an intelligence officer in North Africa and France.

...of all John D. Rockefeller, Jr's offspring, it is David, despite being the youngest, who has emerged as the true heir to the vast reservoir of political and economic power originally amassed by John D. Rockefeller, Sr.

Returning to the US in 1946, David went to work for the "family bank", Chase Manhattan. He started as a low-ranking officer, but, thanks to the Rockefeller family's controlling interest, he rapidly rose through the ranks and in 1969 became Chairman and Chief Executive Officer. David ran the bank until his retirement in 1981, but continued to play a role as Chairman of the bank's International Advisory Committee.

Although David later liked to boast that he was "the first member of the family since Grandfather who has had a regular job in a company and

has devoted a major part of his life to being in business", it was apparently "not an easy decision" as he still desired to work with government or in philanthropy, particularly on international affairs.¹⁰ But, in truth, neither avenue has ever been closed to him.

The Education of an Internationalist

David attributes much of his internationalist fervour to the influence of his parents, his overseas travelling experiences and his changed world outlook following World War II. He writes that it was his parents who first impressed on him "the importance of the world beyond the United States". His father, Junior, "was a staunch supporter of the League of Nations" and, through the Rockefeller Foundation, "one of the principal funders of health, education, and cultural endeavors around the world".¹¹ But there were other influences, including David's education at Harvard University and the University of Chicago during the 1930s, and his early membership of the Council on Foreign Relations from 1949 and the Bilderberg Group from 1954.

It was at Harvard, under the guidance of Professor Gottfried von Haberler (1901–1995), that David received more vigorous indoctrination into the benefits of free trade. Described by David as a "staunch supporter of free trade", Haberler would have given compelling guidance—for the Austrian professor was, according to one biographer, "one of the first economists to make a rigorous case for the superior productivity and universal benefits of 'free' or politically unrestricted international trade..." At the University of

Chicago, these views were reinforced when another free trade proponent, the economist Jacob Viner (1892–1970), tutored David. Lauded by David as an advocate of "unobstructed trade as a means of generating economic growth", Viner was one of the leading free trade theorists of his time. He was also an advocate of using international institutions to manage the world economy. Fittingly, David includes Haberler and Viner among those academics to whom he owes an "intellectual debt", hailing them as "truth seekers" whose example he has attempted to follow.¹²

David joined the Council on Foreign Relations in 1949, his surname ensuring election to its board of directors. David naturally understates the CFR's influence on his thinking, merely observing that he found it to be the "best place" for pursuing his "interest in global affairs". Tellingly, David admits his motivation for joining the CFR was his determination to "play a role" in the process of ensuring the US provided leadership in building "a new international architecture" following World War II. While David correctly identifies the wide range of views among the CFR's members, for him the Council's enduring value has been its role in devising schemes for world order that conform with his Wilsonian vision. For example, marking the CFR's 75th anniversary in 1997, David hailed the Council's role as America's "premier school for statesmen", observing that it was from the CFR's War and Peace Studies project that America's post-war plans for a "just and durable international system" had emerged, and from more recent CFR studies that "awareness of global economic interdependence gained particular prominence in national policy discussions".¹³

In 1954, David was selected by President Eisenhower to be one of the founding US members of the Bilderberg Group. The Bilderbergers have long been controversial, with many researchers attributing to the annual secret gathering a role in establishing the European Union and facilitating the planning of a world government.¹⁴ David insists, naturally, that the "truth" is that Bilderberg is no more than an "intensely interesting discussion group" which does not reach a consensus. What Bilderberg discusses, David does not say, preferring to characterise the cabal as a unique networking opportunity. Bilderberg, David said in 1990, gave him "an opportunity...to become acquainted with some of the leaders of Europe and the United States on a very informal basis...one got to know them on a first-name basis".¹⁵ Other Bilderbergers, however, such as former British politician Denis Healey, admit there is a Bilderberg consensus, with most Bilderbergers believing that "a single community throughout the world would be a good thing".¹⁶ Such a consensus would have obviously reinforced David's globalist inclinations, making the Bilderbergs more than merely an unusually well-connected social rendezvous.

This is but a small sample of the influences on David's globalist outlook, but it also illustrates his reliance on the ideas of others. Despite his PhD, David is not quite the theoretical mastermind behind the New World Order that he appears to be. Instead, like most plutocrats intent on changing the world, he appropriates the

ideas of others, usually Establishment academics and technocrats, incorporating them into his own global vision when it suits his purposes. But, David admits, he has "never been particularly dogmatic" in his political or economic beliefs, preferring to support "effective people and...practical policies".¹⁷ Thus, for David, ideas or protégés can be discarded once they are no longer useful to him or his ultimate goal of "a more integrated global political and economic structure".

A Modern-Day Medici

David Rockefeller's globalist inclinations would be of little interest if not for his uniquely powerful position in the US political sphere. In attempting to describe David's power, academics and journalists have used many superlatives, and it is instructive that these descriptions are similar. David Rockefeller is "[t]he single most powerful private citizen in America today", observed Florida State University academic Thomas R. Dye in his 1976 book, *Who's Running America?* The journalist Bill Moyers, in his 1980 TV special, *The World of David Rockefeller*, described the plutocrat respectively as "the unelected if indisputable chairman of the American Establishment" and "one of the most powerful, influential and richest men in America", who "sits at the hub of a vast network of financiers, industrialists and politicians whose reach encircles the globe". And in 1998, NewsMax.com described David as "one of the world's most influential private figures".¹⁸

David has always rejected such assessments, insisting that his power is limited and that he has no real leverage with world leaders or government officials, merely good access to them. In an interview with *Forbes* magazine in 1972, for example, David downplayed the idea that he had any such power:

I have no power in the sense that I can call anybody in the government and tell them what to do. Because of my position I'm more apt to get through on the telephone than somebody else, but what happens to what I suggest

depends on whether they feel this makes sense in terms of what they are already doing.¹⁹

Dye disputes this, claiming that the real reason for David's elaborate denial is simple: with it already well known that he "exercises great power", the plutocrat has "no reason to try to impress anyone" by openly admitting it. In fact, David's position and behaviour are similar to that of the Medici banking family that unofficially ruled 15th-century Florence by subverting the elaborate electoral system through a combination of deception, corruption and violence. The Medicis were effectively the shadow government of Florence—a fact acknowledged in the Florentine expression, "the secret things of our town". That was because, as Tim Parks notes in the *New York Review of Books*, the Medici family leadership understood that "to hold power for any length of time, one must appear not to hold it".²⁰ Although not known for emulating their more controversial practices, David Rockefeller is like the Medicis, his shadowy yet powerful political role one of the "secret things" of Washington, DC.

David Rockefeller is "the single most powerful private citizen in America today", observed Florida State University academic Thomas R. Dye in his 1976 book, *Who's Running America?*

David's preference for this behind-the-scenes political role stems from his profound distaste for normal democratic politics. Although clearly interested in power, David, after working for Mayor La Guardia, apparently found the idea of having to depend on the whims of the voting public unattractive. "The danger in that field," he later commented, "is that you spend all of your time running for office."²¹ Unstated, of course, is the plutocrat's probable discomfort at the prospect of being publicly accountable in *any way* for his actions—something that would be an affront to the enormous power this Rockefeller saw as his due.

Instead, David found a surer route to power by fulfilling the family tradition of using philanthropy as a "bridge" between the private and public sectors. David typically presents his motives behind his philanthropy as benevolent, an embodiment of Junior's belief that "philanthropy was about being a good neighbor". "I have tried to emulate Father by contributing to a variety of not-for-profit organizations throughout my life," he writes in *Memoirs*.²² But this is disingenuous, for David's actual motives for embracing philanthropy in fact have more in common with Andrew Carnegie's view that the wealthy have an exclusive right to shape society.

It has been in other forums, in little-noticed speeches to elite gatherings, that David's true intentions have been revealed. Like Carnegie, David considers an active political role by the rich to be a matter of duty rather than a mere whim, as he stated to one gathering that "the opportunities for possessing wealth carry with them *comparable responsibilities*".²³ In fact, he told the New York Economic Club in 1996, philanthropy performs a vital social function in which the rich and businessmen in general are able to realise their "*responsibility to society* beyond that of maximising profits for shareholders". Although "making profits must come first", as profits are "the most important instrument we have to promote the broader welfare of our society", David maintained that the captains of industry should style themselves as "business statesmen" and be "vocal and visible...speaking out on community, industry and national issues".²⁴

This also includes active involvement in the non-profit area, supporting various organisations whether dealing with domestic or international issues. There is "nothing wrong with perpetuating one's name by endowing an organization or building", David told the Sid W. Richardson Foundation in 1985, but with government in retreat in many areas, "the private area must take up the slack".²⁵

Unless the business class is actively involved in resolving "societal problems", he warned the New York Economic Club, the public may become "disenchanted with business" and "demand that government *resume its previous role* as the arbiter of our economic life".²⁶

And thus David's real agenda becomes clear: the rich must govern, limiting the role of elected officials; but the multitude must be placated lest they clamour for the return of democracy, threatening the reign of the plutocrats.

Emperor of the Establishment

But what is the source of David's power? It is not just his personal fortune, currently a meagre US\$2.5 billion and a pittance compared to the US\$30 billion or more of today's super-rich such as Bill Gates and Warren Buffet. One obvious source has been his executive positions at the Chase Manhattan Bank. But the primary basis, as Dye explains, is in David's enduring role as "director of the vast Rockefeller empire"; that is, his leadership of "the Rockefeller network of industrial, financial, political, civic, and cultural institutions".²⁷ At the centre of this network are the remnants of the vast fortune originally amassed by John D. Rockefeller, Sr, and then dispersed into an abundance of family trusts and philanthropies. This includes the Rockefeller Foundation (2001 market value of assets, US\$3.1 billion) and the Rockefeller Brothers Fund (RBF) (2002 market value of assets, US\$670 million). As a former Vice-Chairman (1968–1980), Chairman (1980–1987) and now an Advisory Trustee of the RBF, David has always been at the hub of this network.

Outside of this hub is a plethora of public institutions including foundations, non-government organisations and various government advisory boards that David has been involved with, usually in a leading role. His myriad positions include: Honorary Chairman of Rockefeller University; Chairman Emeritus of the Museum of Modern Art in New York City; Chairman of the Americas Society; Director of the US-USSR Trade and Economic Council; Chairman of the New York Chamber of Commerce and Industry; Chairman of the US Advisory Committee on Reform of the International Monetary System; Honorary Chairman of the Japan Society; a director of International House; a trustee of the University of Chicago; a trustee of the John F. Kennedy Library; President of the Board of Overseas Study at Harvard; and now, an honorary jury member on the Lower Manhattan Development Corporation's International World Trade Center Site Memorial Competition.

This impressive range of institutions that David has been involved in also

includes a raft of policy-planning organisations devoted to international political and economic affairs. David's role in these organisations has never been marginal, and his positions include: Director, Chairman and Honorary Chairman of the **Council on Foreign Relations** (CFR); founder, North American Chairman and Honorary Chairman of the **Trilateral Commission**; a life member of the **Bilderberg Group**; Chairman and Director of the **Institute for International Economics** (IIE); founder, Chairman and Honorary Chairman of the **Council on the Americas**; and a trustee of the **Carnegie Endowment for International Peace** (CEIP). He is also a co-founder of the **Dartmouth Conference**, the **International Executive Service Corps** and the **Global Philanthropists Circle**.

At a recent "book party" for the retiring plutocrat, former US Trade Representative Carla Hills celebrated David's pivotal role in maintaining this network:

Instead, David found a surer route to power by fulfilling the family tradition of using philanthropy as a "bridge" between the private and public sectors.

*Had [David Rockefeller] not been the founder, long-time chairman and benefactor and even often all of the above, the Council on Foreign Relations, the Council of the Americas, the Institute for International Economics, the Trilateral Commission, the White House Fellows Program, and I could name so many more, might not exist. And if they did, they might not assuredly be as effective as they are today.*²⁸

True to his Medici-like preference for avoiding public scrutiny, David has rejected formal government appointments, including offers to be Secretary of the Treasury and of Defense, and numerous ambassadorial positions. In *Memoirs*, David cites "political considerations" and his devotion to Chase Manhattan as his reasons for declining these offers. David also believed, not without good reason, that through his Chase chairmanship he could "accomplish much that would benefit the United States as an 'ambassador without portfolio'". At the panel discussion on *Memoirs*, held in October 2002 at Johns Hopkins University, David elaborated further, noting that his position at Chase provided him with "a rather unique opportunity to play a quiet but hopefully useful role". And on the *Charlie Rose Show*, David added that he could achieve much more outside of government as he was not limited to four-year terms, thus enabling him to do "a lot of interesting things" over decades.²⁹

As a self-appointed "ambassador without portfolio", for example, David has used his unique access to visit countless

heads of state, ostensibly on business for Chase or as part of CFR delegations but often as an unofficial emissary for Washington. David has had private meetings with hundreds of national leaders—a privilege usually only afforded to senior officials or other heads of state. The list includes Nikita Khrushchev, Alexi Kosygin, Gamal Abdel Nasser, Deng Xiaoping, Saddam Hussein, Fidel Castro, Zhou Enlai and the Shah of Iran. The product of these associations is a network of power and influence, with David at its centre—ultimately embodied in his massive electronic Rolodex, located in his office in the Rockefeller Center, reputed to contain 150,000 names.³⁰

Continued next issue...

Author's Note:

In Part Four we will continue to examine David Rockefeller's internationalist vision, focusing on his most controversial creation: the Trilateral Commission.

About the Author:

Will Banyan, BA (Hons), Grad. Dip. (Information Science), is a writer specialising in the political economy of globalisation. He was worked for local and national governments as well as some international organisations, and was recently consulting on global issues for a private corporation. He is currently working on a revisionist history of the New World Order. Will Banyan can be contacted at banyan007@rediffmail.com.

Endnotes

1. William F. Jasper, *Global Tyranny... Step By Step: The United Nations and the Emerging New World Order*, Western Islands, 1992, p. 283; John Wilkes, "Hit-job on Margaret Thatcher", in James Gibb Stuart, *Hidden Menace to World Peace*, Ossian, 1993, p. 159; and David Icke, *...and the truth shall set you free*, Bridge of Love, 1995, 2nd edition, p. 173.

2. David Rockefeller, Letter to the *New York Times*, August 25, 1980; and Rockefeller, quoted in Ellen Sorokin, "Trilateral Meeting to discuss terrorism", *The Washington Times*, April 6, 2002.

3. Thomas d'Aquino, "Tribute to David Rockefeller, Honorary Chairman, The Americas Society", On the Occasion of a Presentation to David Rockefeller, Honorary Chairman, Americas Society, during a meeting of the Chairman's International Advisory Council of the Americas Society to Vancouver, June 6, 2002, pp. 1-2, at The Americas Society website, <http://www.americas-society.org>.

4. Neil L. Rudenstine, "Pitching into Commitments", Remarks in Honor of David Rockefeller, Marshall Award Dinner, New York Public Library, May 17, 1999, in Neil L. Rudenstine, *Pointing Our Thoughts: Reflections on Harvard and Higher Education, 1991-2001*, President and Fellows of Harvard College, 2001, p. 217.

5. Georges Berthoin, Shijuro Ogata, Conrad Black and Henry Kissinger, "Toasts to the Trilateral Commission Founder and Honorary Chairman, David Rockefeller", on the occasion of the US Group's 25th Anniversary Evening, December 1, 1998, at <http://www.trilateral.org>.

6. UN Secretary-General Kofi Annan, "Remarks at book signing by David Rockefeller",

December 17, 2002, at <http://www.un.org>.

7. David Rockefeller, *Memoirs*, Random House, 2002, p. 405 (emphasis added). Despite its immeasurable significance, NWO researchers seem either unaware of or to have ignored David's admission. One of the few exceptions is Richard C. Sizemore, "David Rockefeller: His Memoir Revelations", January 1, 2003, at <http://www.Sanspap.com>.

8. Peter Collier and David Horowitz, *The Rockefellers: An American Dynasty*, Holt, Rinehart & Winston, 1976, p. 222.

9. Rockefeller, *Memoirs*, p. 4 (emphasis added).

10. Rockefeller, quoted in Ron Chernow, *Titan: The Life of John D. Rockefeller, Sr.*, Warner Books, 1998, p. 662; and Rockefeller, *Memoirs*, pp. 122, 145.

11. Rockefeller, *Memoirs*, p. 406.

12. *ibid.*, pp. 80, 89, 91-92; Joseph T. Salerno, "Biography of Gottfried Haberler (1901-1995)", Ludwig von Mises Institute website, <http://www.mises.org>; and "Jacob Viner, 1892-1970" at The History of Economic Thought website, <http://cepa.newschool.edu/het/>.

13. Rockefeller, *Memoirs*, p. 406; David Rockefeller, *The Council at 75*, September 1997, at the CFR website, <http://www.cfr.org>.

14. See, for example, Mike Peters, "The Bilderberg Group and the project of European unification", *Lobster* 32, December 1996.

15. Rockefeller, *Memoirs*, pp. 410-411; and Rockefeller, quoted in James A. Bill, *George Ball: Behind the Scenes in US Foreign Policy*, Yale University Press, 1997, p. 54.

16. Healey, quoted in Jon Ronson, *Them: Adventures with Extremists*, Picador, 2001, p. 299.

17. Rockefeller, *Memoirs*, p. 486.

18. Thomas R. Dye, *Who's Running America?:*

The Carter Years, Prentice-Hall, 1976, p. 157; Moyers, quoted in Larry Abraham, *Call It Conspiracy*, Double A Publications, 1985, p. 37; and "David Rockefeller to the Rescue", NewsMax.com, October 16, 1998, <http://www.newsmax.com>.

19. Rockefeller, quoted in Dye, *Who's Running America?*, p. 160 (emphasis added).

20. *ibid.*; Tim Parks, "Mad at the Medicis", *New York Review of Books*, May 1, 2003.

21. Rockefeller, quoted in Collier and Horowitz, *The Rockefellers*, p. 225.

22. Rockefeller, *Memoirs*, p. 488.

23. David Rockefeller, "Giving: America's Greatest National Resource", *Vital Speeches of the Day*, March 15, 1985, p. 328 (emphasis added).

24. David Rockefeller, "America After Downsizing", *Vital Speeches of the Day*, September 12, 1996, p. 42 (emphasis added).

25. Rockefeller, "Giving", pp. 330, 331.

26. Rockefeller, "America After Downsizing", pp. 41-42 (emphasis added).

27. Dye, *Who's Running America?*, pp. 153, 157.

28. Carla Hills, Zbigniew Brzezinski, Riordan Roett and David Rockefeller, *Memoirs: The Rockefeller Family in International Affairs*, Panel discussion on David Rockefeller's new book at the School of Advanced International Studies, Johns Hopkins University, October 31, 2002.

29. Rockefeller, *Memoirs*, pp. 485-487; Carla Hills et al., *Memoirs: The Rockefeller Family in International Affairs*, *ibid.*; Interview with David Rockefeller, *Charlie Rose Show*, October 21, 2002.

30. See "A Wealth of Names", January 10, 2000, at <http://www.Forbes.com>.

PROJECT HAMMER RELOADED

Riches looted by the Nazis and Japanese during WWII and recovered by the United States OSS and CIA have been used to finance secret government projects over the decades and save major banks from insolvency.

Part 1 of 2

by David G. Guyatt © 2003

c/- NEXUS Office
55 Queens Road
East Grinstead, W. Sussex RH19 1BG
United Kingdom

Website:
<http://www.deepblacklies.co.uk>

BACKGROUND ON "COLLATERAL TRADING"

Beginning in 1988 and lasting until approximately 1992, "Project Hammer" was the latest in a series of highly secretive banking practices—known as "collateral trading" programmes—that are used to create, as if by magic, huge amounts of unaccountable funds for use in specific projects.

These vast pools of unvouchered slush funds are applied to finance a wide variety of clandestine activities that include secret military projects, geo-political requirements and the development of infrastructure projects.

It is also whispered that, in the case of the Project Hammer programme at least, a percentage of the proceeds generated from this secretive activity found its way into the pockets of VIPs and well-known politicians. Names associated with such corrupt behaviour are carried on the wind; but if one listens attentively, the names George Bush, Sr, and Jim Baker III are just discernible to the trained ear.

An example of the type of project on which these funds are expended is the trading programme known as "EFG Jacobi"—a predecessor of Hammer—that I understand was used largely to finance military facilities and related operations at the top-secret US base located at Pine Gap near Alice Springs in central Australia.

In order to maintain the secrecy that surrounds genuine activity, these trading programmes are routinely said not to exist. Enquiries about them are deflected and attention is instead focused on the warnings issued by government agencies about fake programmes. This, when combined with the numerous prosecutions that occur every year over fraudulent High Yield Investment Programme transactions, serves to create the impression that authorised programmes do not occur.

The reasons for this deflection are many, but not least is the fact that the asset bases on which these programmes usually operate are also said not to exist—at least in the quantities that they actually do. The assets in question are large volumes of gold and lesser amounts of platinum plundered by the Nazis and Japanese during World War II.

The fact that gold has been the one stable commodity used to back and support the issuance of currency over the decades means that it has been subject to considerable government and central bank secrecy. It was only in 1997 that the Bank of England decided to lift this veil of secrecy and allow the London bullion market a degree of openness. But that openness did not include coming clean about the true amount of gold in existence, which is far larger than official figures allow.

Because of this and the extremely covert nature of related trading programmes, comprehensive details of the programmes' operations and the financing techniques employed have remained hidden from public view. At least this was the case prior to the publication of part one of this series, *The Project Hammer File*.¹ This essay is the result of further examination of the techniques and activity of Project Hammer, and now places additional important material into the public domain.

Project Hammer remains a high-level state secret in a number of countries including the USA. This was confirmed *de facto* by the CIA in its refusal to release any relevant information following my Freedom of Information Act request in February 2001. The exemption used by the CIA to reject my request was that relevant material is "properly classified pursuant to an Executive Order in the interest of national defense or foreign policy".²

Project Hammer also stands out because proceeds from the trading activity were illegally diverted by major banks. Confirmation of this is provided by Brigadier-General Erle Cocke in his April 2000 affidavit. In this, General Cocke was asked about the

involvement of former US Treasury Secretary Lloyd Bentsen, who was retained to investigate what had happened to (and also to recover) the missing funds. Asked if Bentsen "had the government's interest in closing this whole problem" and if he had "ever had a discussion" with Bentsen, Cocke replied:

Many hours just trying to find out whether any agency, any group, Federal Reserve, Treasury, CIA, FBI, security agencies, and so forth, all of them put together, whether any of which would really like to finish. And, quite frankly, nobody stepped up to the plate.

Cocke was then asked if "they would like to finish it", and he responded:

I think they would like to finish it, but they all back away. It is not my cup of tea, or they have spent enough time with it and are not going to realize anything, and therefore they just quit. They don't confirm, they don't deny, they just stop.

One can conclude that the banks that diverted this money were too powerful for any agency of the US government to tackle. It also helped that suitable and substantial "incentives" were provided to former high-level Bush (Sr) Administration figures to bring their influence to bear quietly to ensure that action against the banks was not taken.

Although not part of the sanctioned plan for Project Hammer—which was to generate funds to pay off debts on bullion certificates issued by certain metal trusts—the funds were siphoned off surreptitiously in order to rescue numerous major US and other banks that by the latter half of the 1980s were tottering on the brink of bankruptcy.³

The banks only had themselves to blame for their imminent collapse. Reckless lending to Third World nations for over a decade or more, combined with the raw greed of senior bank executives, had caused unparalleled damage to the world's banking system. The inability of indebted Third World nations to repay their massive debts could have been—in fact, was—foreseen, but was ignored.

The spiral of gluttony had taken prisoner the faculty of prudence and reason as bank executives, seeking their next bonus and promotion, pleaded with sovereign nations to take loans they did not need and ultimately could not repay. Nor was it unusual for some of the funds on loan to find their way into the private bank accounts of corrupt state officials—"diversions" that were known about in the boardrooms of the top banks, but ignored as "business as usual".

By the end of the 1980s, big banks including Citibank, Chase Manhattan, the Hongkong and Shanghai Banking Corporation (HSBC), England's Midland Bank and many, many others were in dire straits. In all but name, they were bankrupt. The possibility of a prolonged series of collapses of the world's top banks—a sort of "domino theory" of finance—was regarded in some quarters with palpable fear. The entire Western banking system was rocking when it should have been rolling along nicely.

Somewhere, someone—nobody knows who (or at least no one is saying)—took the decision to bail out the banks and save the banking system by diverting Project Hammer funds for this

purpose. Those banking executives who caused the problem in the first place weren't confronted by their mistakes or held to account by their shareholders but, instead, continued to collect their million-dollar pay cheques, boost their bonus payments and profit shares, flick ash off their Cuban cigars, quaff bottles of expensive Cheval Blanc and slap each other on the back in delighted relief. One of those sighing relief was almost certainly Citibank's John Reed. Another one quite likely to have been cultivating a quiet exhalation was Hongkong and Shanghai Bank boss Sir William Purvis.

Meanwhile, many investors who had placed their money into Project Hammer in return for an agreed profit, as well as all those middle-men who had worked hard for their promised commission, were relieved of their money in a twisted version of the well-known axiom, "One man's loss is another banker's gain".

STEALING FROM THIEVES

The sanctioned purpose of Project Hammer was of a macro-economic nature, which is a nice way of saying that it was all to do with "repatriating" the assets stolen earlier by someone else—except that when nations steal valuable assets during wartime, it's called "plunder"; but when the victors in that war grab those same assets, they call it "recovery".

The assets in question were a vast horde of gold and lesser quantities of platinum plus not inconsiderable amounts of loose gemstones which had been grabbed by the Nazis and the Japanese during World War II. A large volume of this loot found its way to the Philippines where it was hidden in numerous treasure sites by the Japanese occupiers, who planned to recover it after the war.

But it didn't quite work out the way the Japanese had planned. They lost the war, along with the Philippines—which, it seems, they had been fairly confident of being allowed to keep in a negotiated truce with the Allies.

In their place, the OSS—the wartime forerunner of America's spy agency, the Central Intelligence Agency (CIA)—began recovering the bullion plundered from a dozen or so nations. This bullion formed what became known as the "Black Eagle" fund, which was part of a secret agreement eclipsed behind the 1944 Bretton Woods Agreement. Consequently, the metal was placed under the care of OSS (and later CIA) operative Severino Garcia Santa Romana, who put it under the control of numerous corporate entities he formed for the purpose. These entities, in turn, proceeded to establish 176 bank accounts in 42 different countries in which to deposit these assets under private treaty agreement.

Confirmation of this came from General Cocke, after this was put to him: "I have been advised that a chunk of the Hammer Project funds that were used to trade, to invest and reinvest, came from a large block of assets that CIA put into the bank [Citibank]." Cocke replied: "And they pulled that several times from several sources. Nobody is going to confirm it."⁴

Santa Romana died in 1974, and following his death his former attorney and trustee was able to "acquire" considerable portions of Santa Romana's estate by illicit means. The lawyer was Ferdinand Marcos, who went on to become President of the Philippines and a favourite friend of the United States until his overthrow in 1986. The acquisition of these assets helped give

One can conclude that the banks that diverted this money were too powerful for any agency of the US government to tackle.

rise to stories of "Marcos gold"—a legend that was supplemented by additional later recoveries of WWII gold and other loot using a Filipino Army battalion under the overall command of Marcos henchman General Fabian Ver.

But Marcos was not the sole illegitimate beneficiary of war loot once controlled by Santa Romana. Another was the late Baron Krupp who, I have been told, also gained access to some of these assets. Meanwhile, it is worth mentioning that Santa Romana, prior to his death, was apparently associated with former US President and head of the CIA, George H. W. Bush, and "had some contact" with Jeb Bush, the Governor of Florida.

In any event, this bullion has collectively given rise to a whole class of gold and platinum certificates issued over the decades, mainly by top-drawer European banks. The certificates bear the names of prominent, and in some cases infamous, individuals—usually heads of state—as beneficiaries. However, these named owners were and are not the legal beneficiaries but, rather, were cat's-paws used to muddy the waters concerning the true origin of the bullion. Nor did the banks that held the assets own them, but they could and did use them in support of their off-balance sheet activity—to the point of irresponsibility.

It should not be forgotten that this gold and platinum hoard was stolen and that, under international law, every effort should have been made to return it to its rightful owners—rather than secretly stash it in bank vaults for use in Cold War covert operations. And although it can reasonably be argued that the true owners could never be traced—since the greater quantity of the bullion was privately owned (rather than being central bank bullion)—it is clear that the ends dictated the means.

And even though numerous nations around the world were to benefit from post-war reconstruction based on the use and application of this war booty, the price of this apparent largesse was for these nations to be moulded into Uncle Sam's image. As they say in America's boardrooms, "There's no such thing as a free lunch".

In examining the techniques employed in setting up Project Hammer, one is struck not just by the complexity of it but also by the way the banks and intelligence agencies involved structured things to shield themselves from responsibility (and lawsuits, no doubt) by utilising subterranean networks, each working at "arm's length".

Piecing these techniques and networks together has been an arduous, painstaking task, but the process has further unveiled a shadow world of parallel finance usually only known to those initiated into it.

THE EMPIRE STATE CONNECTION

During his April 2000 deposition, just days before his death from cancer, Brigadier-General Erle Cocke, when asked about the overall objective of Project Hammer, replied:

Well, it was mainly to bring back monies to the United States from all types of activities, both legitimately and

illegitimately. Not that they were in the smuggling business per se, but they were all in the arms business, they were all retracing dollars of one description or another that had accumulated all through the '40s and '50s, really. And that probably is as broad a definition as I can give you...

General Cocke then added that involvement in Project Hammer extended to:

*...the CIA, the FBI, the National Security Agencies of all types, Pentagon in the broad sense of it and as such, the Treasury, Federal Reserve. Nobody got out of the act, everybody wanted to get in on the act.*⁵

Cocke's involvement with clandestine CIA activities dates back many years. At the very least, he is known to have been involved with the CIA's Nugan Hand Bank. For example, US Treasury records obtained by veteran journalist and author Jonathan Kwitny show Cocke as the registered "person in charge" of Nugan Hand's Washington office.⁶

Cocke also indicated in his affidavit that he was regularly contacted by the CIA for expert assistance over the years and was usually debriefed by them following overseas travel. Despite this, a Freedom of Information Act request to the CIA made on behalf of this writer was dismissed with the statement that "...no records responsive to your request were located"—which is not entirely the same thing as saying that no records exist.⁷

It also appears that the CIA is not the only one that cares to deny knowledge of General Cocke. Another is former Citibank CEO and Chairman John Reed, who, in a sworn affidavit dated 5 December 2000, stated he had "no knowledge of any persons named Erle Cocke, Jr, or Barrie D. Wamboldt". Both the CIA and Citibank's John Reed hold at least one major advantage over General Cocke: they are alive and he is dead; and while it is true that the dead can't lie, it is also true that they can't rebut anyone's testimony—sworn or otherwise.⁸

In his deposition, Cocke states that although he had never "met" John Reed, he had attempted on numerous occasions to speak with him, but was continually rejected:

*We did our best to make the normal approaches, but I can see the President of the United States with no trouble. I cannot see Reed.*⁹

The "we" Cocke was referring to, besides himself, was Paul Green, a "long-time real estate lawyer in New York" with "50 years practice", who "had done most of his real estate dealings through Citibank".¹⁰ Green also did some of his banking business with Citibank at its Fifth Avenue, New York, branch under account FOCUS #946 963 94.

According to Cocke, Paul Green was an outside counsel for Citibank and went back "...30-odd years with large transactions through that bank, buying and selling big buildings. He was very much involved buying and selling the Empire State Building one

In examining the techniques employed in setting up Project Hammer, one is struck not just by the complexity of it but also by the way the banks and intelligence agencies involved structured things to shield themselves from responsibility...

time."¹¹ Asked if Green was involved in the purchase and sale of collateral instruments, Cocke replied:

*Probably not as an individual. But he represented the clients that certainly wanted to do the same thing.*¹²

News in late March 2003 revealed that the Empire State Building had just been sold by casino king Donald Trump and the heirs of shady Japanese billionaire Hideki Yokoi for US\$57.5 million. Yokoi (who, at the time, was serving a prison sentence and had secretly negotiated the transaction through a middleman) and his partner Trump had gained ownership of the building in 1991 for US\$42 million. Little is known about Yokoi's World War II activities.

The building last changed hands four decades earlier in 1961, when it was acquired by real estate tycoon Harry Helmsley from the Prudential Insurance Company in a sale-leaseback deal. The world-renowned skyscraper was built on land owned by the Astor family and sold to the DuPonts in 1929. Construction of the Empire State Building began in 1930. John Jacob Astor was one of the first Americans to become involved in the opium trade, from which his later fortune derived. This he invested in Manhattan real estate. The architects of the Empire State Building were Shreve, Lamb & Harmon Associates—designers of One Bankers Trust Plaza, the HQ of Bankers Trust, together with the Credit Lyonnais building in New York City.

It is of more than passing interest that one law firm represents many of the "actors" who appear in this story. That firm is White & Case. Amongst numerous notable achievements listed on its website background/history is its representation of the DuPont Group in its sale of the Empire State Building in 1954 for the princely sum of US\$51.5 million. As we noted earlier, almost 40 years later, in 1991, the building sold for the less than princely sum of US\$42 million. I am not certain how the real estate investors define investment performance over the years, but an aggregate loss of US\$9.5 million over the course of 37 years doesn't usually constitute an investment accomplishment by any standard I know.¹³

Meanwhile, a brief review of White & Case's client list tell us that they also represented the First National Bank (the forerunner of Citibank), Astor Trust Company,¹⁴ Prudential, J. P. Morgan & Co., Saudi Aramco, Swiss Bank Corporation and Seagram Company Ltd of Canada, controlled by the Bronfman family—regarded by some as the kings of the Canadian mafia.¹⁵ But White & Case's most "enduring" client is Bankers Trust Company, a J. P. Morgan-controlled bank which the law firm was "centrally involved" in forming back in 1903.

The ancestor of all trust companies is England's Foreign & Colonial Investment Trust, which dates back to 1868 and was conceived by one of the foremost legal minds of the day, Lord Westbury. The current Lord Westbury, Richard Bethell, will appear later in this story.

But first, let's step through the looking glass and examine one of the early Hammer deals, which General Cocke believed:

...was one of the very early transactions, as far as I am concerned, with Hammer. I think he [Dan Hughes] is the one who expanded Hammer in the sense that we moved from one hundred million [dollars] to a billion-type movement, and now we are doubling, about a trillion. He is the one who enhanced it, is the best way of saying.

THE HUGHES PORTAL

Dan Hughes, Jr, the nephew of US Representative William J. Hughes from New Jersey, made a considerable fortune in the construction business in Florida during his early working life. By the mid-1980s, with paper assets nearing US\$100 million, he became involved in collateral trading and by late 1989 entered the realm of Project Hammer.

During the autumn of 1989, Hughes was approached by Peter Seaman, the President and Chairman of a small investment bank called Nantucket Holding Company. Seaman had developed an arrangement with Ecoban Limited, a small merchant bank with offices in London and New York City that specialised in emerging market-debt and the A'forfait market.¹⁶ Seaman, using Nantucket Holding Company, concluded an agreement by which Ecoban would purchase US\$100 million worth of documentary letters of credit issued by the head offices of Citibank NA and the Chase Manhattan Bank NA. Hughes had access to these bank credits via a US\$50 billion "commitment" extended to him by the Bankers Trust Company.

To fund the purchase, Ecoban needed the support of a bank and turned to Midland Bank Aval Limited (MidAval), the forfeiting subsidiary of Midland Bank Group International Trade Services (MiBGITS). MidAval, once wholly owned by Midland Bank, had, shortly before commencing with the Hammer transaction, concluded a private agreement with Sir William Purvis, Chairman of the Hongkong and Shanghai Banking Corporation, where-in HSBC purchased a controlling equity stake in MidAval. This meant that MidAval was 60% owned by HSBC

and 40% owned by Midland Bank.¹⁷

Accordingly, on 12 October 1989, MidAval issued a letter agreeing to purchase "\$100 million *with rolls until funds are exhausted* of documentary letters of credit..."¹⁸ An earlier MidAval letter (dated 25 September 1989) stated that they "irrevocably commit to purchase the above letters of credit and pay the amount agreed between you and Ecoban Limited ('the purchase price') to Citibank NA, Lugano".

The reference to "Lugano" was deleted in later letters at the specific request of Nantucket's Peter Seaman, as detailed in his 11 October 1989, letter to Brian Fitzpatrick, the Managing Director of Ecoban Limited. Lugano was of some considerable importance—as we shall see later—but not least because it was at Union Bank of Switzerland in Lugano where, according to Dan Hughes, the actual trading of the Hammer programme took place.

Meanwhile, MidAval's letter was addressed to Jardine, Emett & Chandler, New England, Inc., in Boston, USA, which acted as an agent for MidAval. On the strength of MidAval's signed and

The ancestor of all trust companies is England's Foreign & Colonial Investment Trust, which dates back to 1868 and was conceived by one of the foremost legal minds of the day, Lord Westbury.

authorised letter, Jardine, Emett & Chandler issued its own "Request for collateral instruments" under its letterhead. This letter, dated 12 October 1989, bore the reference "Midland Bank Aval Limited for Ecoban Limited".

To close the circle, Dan Hughes had earlier instructed his attorney, Oswald (Ozzie) Howe, Jr, of the Miami law firm Mershon, Sawyer, Johnston, Dunwoody & Cole, to cause to be issued a sight draft, dated 6 October 1989, drawn on the Southeast Bank NA, Miami, and payable to Bankers Trust Company, for the sum of US\$50,000. A further sight draft was issued in the amount of US\$25,000, at the request of Bankers Trust. Following this sequence of events, nothing happened and no draws were made against the sight drafts issued by Southeast Bank in favour of Bankers Trust. But on 18 October 1989, Hughes received a time and sequence confirmation from Joan Johnson, Vice President and Operations Manager of the Security Pacific bank in Los Angeles, which Hughes believes activated his transaction through a "back door" arrangement which would cut him out of his commission.¹⁹ Thereafter, Peter Seaman point-blank and inexplicably refused to speak with Hughes again.

General Cocke was an experienced banker from a long line of bankers and was a former full-time US representative at the World Bank. Intimately familiar with the operational techniques of trading programmes, he was asked: "Can you explain in a general way how it [Hammer] functioned, that it was a trade programme, for those of us that are not familiar?"

The stock way all big banks, all central banks, change within themselves and curtail their balances, build up their peaks and then sell it.

He went on to explain that "most of it is done in a four-week program to be technically correct" and involved the trading of banking instruments—usually known as "collateral"—that are heavily discounted and then sold off.

MAPPING THE COVERT CONNECTIONS

To appreciate the subtleties of how the diversion of this particular "portal" into Project Hammer may have occurred, it is instructive to look at the connections and associations of the principal players.²⁰

• **Ecoban:** In addition to Ecoban Limited in London, there was the affiliated Ecoban Finance Limited that conducted business out of an address on Third Avenue in New York City.

A one-time President and CEO of Ecoban Finance Limited in New York was Jim Demitrius, who more recently was the President and Chief Operating Officer of Ixnet/IPC, which was acquired by Global Crossing in June 2000. Global Crossing was one of the US firms that recently suffered a spectacular collapse together with Worldcom, Enron and the accountancy firm Arthur Andersen. All were subjected to a welter of media attention for what was believed to have been unparalleled insider trading activities by senior executives.

Earlier in his career, Demitrius "served as senior vice president and chief operating officer of the Commodity Division of Drexel Burnham Lambert, Inc., responsible for the precious metals, energy products, foreign exchange trading subsidiary and institutional

brokerage division". Of interest here is the little known fact that Drexel, Burnham, Lambert, New York, was a recipient of gold bullion from Philippine dictator Ferdinand Marcos in January 1984. It is not clear from Mr Demitrius's available *vitae* if this was the same time period he was the Senior Vice President of Drexel's bullion business, but I am informed this is probably the case. Before that, Demitrius "held senior-level financial positions with Freeport–McMoRan, ITT and Arthur Andersen".²¹

Significantly, Freeport–McMoRan, back when it was Freeport Sulphur, positively heaved with CIA and elite heavy-hitters—not to mention persistent whispers of its involvement in the recovery of plundered gold stashed in Indonesia, where Freeport had the world's largest copper mining operation. Over the years, the Freeport senior management has included such luminaries as Augustus "Gus" Long, Chairman of Texaco, who did "prodigious volunteer work for Columbia Presbyterian Hospital"—which has been described as a "hotbed of CIA activity".²²

Another director was Robert Lovett, who has been described as a "Cold War architect" and was once an executive at the old Wall Street bank of Brown Brothers Harriman. He also served as an Under Secretary of State, Assistant Secretary of War and

Secretary of Defense. He was a best friend of Chase Manhattan Bank Chairman (and Warren Commission member) John J. McCloy.

The Chase Manhattan and Citibank connection to Freeport was further enhanced by the board appointment of Godfrey Rockefeller, brother of James Stillman Rockefeller who was appointed Chairman of Citibank (then known as First National City Bank, or FNCB for short) in 1959. (Note, too, that Chase Manhattan and Citibank are the exact same two banks that were to issue the Project Hammer documentary letters of

credit.) Godfrey Rockefeller was a one-time trustee of the Fairfield Foundation that financed a variety of CIA "fronts". Meanwhile, Stillman's cousin, David Rockefeller, was Chairman of Chase Manhattan and regarded as the "goliath of American banking".²³

By a strange coincidence of fate, it was Robert Lovett and John J. McCloy who, together with Robert B. Anderson, formed Secretary of War Henry L. Stimson's team of financial experts concerned with tracking WWII gold looted by the Axis powers. Indeed, Lovett and McCloy were responsible for negotiating the secret agreement hidden behind the Bretton Woods Agreement concerning the establishment of the Black Eagle trust that was to make use of plundered WWII bullion in the postwar years.²⁴

• **Midland Bank:** When looking at MidAval's parent, Midland Bank Group International Trade Services (MiBGITS), one could do worse than read the very informative book by former arms company chairman Gerald James, entitled *In the Public Interest*. James recounts numerous chilling accounts of Her Majesty's intelligence service MI6's deep involvement with the MiBGITS special defence unit. Included are details of Stephan Kock, who James claims to have been a former head of the Foreign Office's so-called assassination squad, Group 13. Another intelligence-connected individual named in James's book is Sir John Cuckney, who was a non-executive director of Midland Bank from 1978 until 1988 and was responsible for having formed the defence unit

To appreciate the subtleties of how the diversion of this particular "portal" into Project Hammer may have occurred, it is instructive to look at the connections and associations of the principal players.

in the first place. Gerald James and his munitions company Astra also had dealings with, and a private account at, MidAval.²⁵

Kock's boss at Midland was Comte Herve de Carmoy, a Frenchman and a leading light on the Trilateral Commission. He left Midland in 1988 to take up the position as the most senior executive of Belgium's massive transnational company, Société Générale. He was replaced as head of Midland International by John Louden, a multilinguist who had an unfortunate speech impediment—leading wags in the bank to say of him that he could stutter in seven languages. De Carmoy's departure was followed by that of both Cuckney and Kock, after what Gerald James describes as "funny practices" relating to a loss of £100 million involving all three men.²⁶

Although a similar amount to the MidAval's Project Hammer transaction, this sum of £100 million cannot have been the same money for two reasons. Firstly, the Hammer amount was in dollars and not pounds, and was discounted at approximately 4% over the prevailing one-year interest rate (LIBOR—the London Interbank Borrowing Rate). For US banks of the standing of Chase and Citibank, at that time a market rate of perhaps one quarter of 1%—or, at most, one half of 1%—was applicable. Four per cent was unheard of by a very long shot indeed. Secondly, at least a year separated the two movements of money.

Even so, there are notable connections between the MidAval CEO Ian Guild and Herve de Carmoy (who was known in the bank as "Herve the Swerve"). Firstly, de Carmoy was Guild's overall boss. Secondly, shortly after de Carmoy moved to Société Générale, a valued employee of MidAval (also a Frenchman, referred to in-house by the affectionate nickname of "Froggy") left MidAval employment to take up the post of Chef du Cabinet at the specific invitation of de Carmoy. Thirdly, Guild and the other two senior executives, plus some other staff, left Midland in 1990 to form IndoSuez Aval Limited. IndoSuez Bank was directly owned by Société Générale and negotiations between de Carmoy, his Chef du Cabinet—the former MidAval employee—

and the three senior MidAval executives had been ongoing for almost a year before satisfactory terms were settled.

Following the takeover of Midland Bank by HSBC, MidAval had its name changed to HSBC Forfaiting Limited. It was dissolved in February 2000. Former staff had long since scattered with the four winds. IndoSuez Aval Limited is likewise now defunct.

Continued next issue ...

Author's Note:

Documents and other exhibits in support of this story are available on my website, <http://www.deepblacklies.co.uk>, where they can be downloaded by interested readers.

About the Author:

David Guyatt spent 28 years working as an investment banker in the City of London. His last position was as a divisional treasurer of a major international bank.

David now pursues a career in journalism, writing for a variety of media and researching and producing factual material on a wide range of associated subjects. This is his 10th article for NEXUS, the most recent published in 9/01–9/02 ("Project Hammer" parts one and two).

In addition to his feature writing, David has prepared background papers on Anti-Personnel Electromagnetic Weapons for the International Committee of the Red Cross (ICRC), was a contributing member of ICRC's SirUS Project that sought to define criteria for judging "abhorrent weapons", and has written for the World Development Movement on his "insider's knowledge" of international weapons financing. He has been a consultant on Swiss and UK TV documentaries, exposing the threat of non-lethal weapons and Britain's weapons trail to Indonesia. He assisted the US-based law firm Easton & Levy in its lawsuit against the Vatican for the restitution of the Nazi Croatian Treasury which was illicitly transferred to the Vatican and elsewhere at the end of World War II.

David has recently completed an in-depth investigation into the black market of gold and has published it as an electronic book, titled "The Secret Gold Treaty", which is available through his home page at <http://www.deepblacklies.co.uk>.

Endnotes

1. Available for free download at <http://www.deepblacklies.co.uk>; also see NEXUS 9/01–9/02.
2. See Project Hammer part one, "The Project Hammer File", freely available on my website, <http://www.deepblacklies.co.uk>.
3. Information about Project Hammer has been garnered from numerous sources. Those sources that I am able to name are named in the text. The remainder remain confidential.
4. Page 51 of General Cocke's affidavit. One of the CIA "sources" was the slush fund controlled by Japanese Liberal Democrat Party bosses and known as the "M-fund", after General MacArthur's economic supremo in Tokyo, General Marquat.
5. General Cocke's 67-page affidavit is available for free download at my website, <http://www.deepblacklies.co.uk>: just click on the Project Hammer File link and follow the instructions.
6. See Jonathan Kwitny's excellent book, *The Crimes of Patriots* (Touchstone Books, New York, 1987), for a detailed background on the Nugan Hand Bank affair.
7. See <http://www.deepblacklies.co.uk/cocke-news.html> for a copy of the CIA's letter.
8. See <http://www.deepblacklies.co.uk/cocke-news.html> for a copy of the cover sheet of John Reed's affidavit.
9. See page 43 of Cocke's deposition at lines 11, 12 and 13.
10. From Cocke's affidavit.

11. See pages 40 and 41 of Cocke's deposition at lines 19 through 21 and 1 through 6.
12. *ibid.*, page 41 at lines 9 and 10.
13. If one includes the inflationary effect over this time period, it would reveal that the sale price is, in fact, a great deal less now than it was almost 50 years ago, which is more than curious. Nor does the leasing agreement over this same period seem especially lucrative.
14. It is not clear from the banking records I have viewed online, but it looks as though the Astor Trust Company was absorbed into an entity that formed part of the Bankers Trust Company.
15. See *Dope, Inc.* (EIR, 1992).
16. Forfaiting is the discounting of bank-guaranteed receivables (Aval) on a non-recourse basis.
17. I use the term "private agreement" under advice—following a recent telephone conversation with a representative of Companies House, who told me that no change of ownership notification had been made for MidAval at that time. MidAval had first been registered as a limited company under the shelf registration name of "Diploma Twenty Nine Limited" in June 1983. A change of name to Midland Bank Aval Limited was formally notified to Companies House in April 1996—although the firm had been trading in the name of Midland Bank Aval Limited from day one. Following the full buy-out of Midland Bank PLC by the HSBC Group, MidAval had its name changed to HSBC Forfaiting Limited. The company was dissolved in February 2000.

18. Italics are mine.
19. Sworn and notarised affidavit of Dan Hughes, dated December 31, 1990.
20. There are believed to have been numerous different "portals" providing access into Project Hammer over the period of its life. The Dan Hughes transaction was one of these—albeit a significant and "early" one, according to the testimony of General Erle Cocke.
21. Demitrius's *vita* is drawn from that published on the Global Crossing website.
22. For details concerning the Freeport Board of Directors, see Internet report entitled "Freeport Sulphur's Powerful Board of Directors".
23. See Phillip Zweig's massive book, *Wriston* (Crown Publishers, New York, 1995) for comprehensive background on Citibank and Chase.
24. For details of these three gentlemen's involvement in the Black Eagle Trust, see Seagrave's self-published book, *Gold Warriors*; details are available on my website, <http://www.deepblacklies.co.uk>, linked under the heading of "The Seagrave Affair" on the main page.
25. I know much of the inner workings of MidAval for the simple reason that I was the Treasurer and an Associate Director of that firm until 1991. However, I knew nothing of the Project Hammer deal that was strictly handled by the three principal executive directors.
26. See details on page 164 of Gerald James's book, *In the Public Interest* (Warner Books/Little, Brown, London, 1996).

SMOG-BUSTING AND RAIN-MAKING WITH ETHERIC ENERGY TECHNOLOGY

from Etheric Rain Engineering Pte Ltd © 1990–2003

Editor's Note: Trevor James Constable, who was born in New Zealand in 1925 and migrated to the United States in 1952, was in the merchant marine—in NZ, Britain and the USA—for nearly half a century. He developed a method of weather manipulation called Etheric Rain Engineering, which expanded on Dr Wilhelm Reich's Cloudbuster technology. He is well known as the author of *The Cosmic Pulse of Life (1975)* and a number of books about German and Allied fighter pilots of World War II. In his investigations of unusual phenomena, he has photographed UFOs as well as huge plasmoidal aerial creatures which he calls "critters".

Trevor Constable is Chief Consultant with Etheric Rain Engineering Pte Ltd, based in Singapore (see website <http://www.ethericrainengineering.info>). The following paper from ERE highlights several of Constable's etheric weather engineering projects.

This specially prepared Internet report is the first time that the historical work-up to 1990's Operation *Clincher* has been presented for the world public. While Etheric Rain Engineering Pte Ltd of Singapore no longer offers dedicated smog abatement contracts, the corporation may, in certain circumstances, make the technology available gratis to governments contracting for rain engineering operations. The extreme simplicity of the technology and the impossibility of protecting that technology via patents or other security measures precludes smog contracts as a practical matter.

ERE's predecessor groups were spectacularly successful against southern Californian smog in the 1987–90 period. Pre-notified etheric engineering operations against metropolitan smog began in 1987 with the pioneer project, Operation *Victor*. Prior to *Victor*, convincing evidence of the power of vertically acting etheric vortices, together with practical experience in their use, was obtained at sea.

Operation *Clincher* in 1990 was thus the result of lengthy, hands-on experience in using etheric force in a vertical format. In no sense was *Clincher* a fluke or a spurious, sudden entry into the smog scenario. The statistical record for 1986–1990 proves this decisively. The 14 stations used in *Clincher* could easily today be increased to 50 or 100 stations to wipe out this health-wrecking scourge. One per cent of current smog-control budgets would finance such an effort.

The truth is that political, bureaucratic and financial forces are heavily invested in smog, and exploit smog economically, financially and politically. This racket depends for its existence upon the lie that there is no effective technical answer to smog, only immensely expensive, marginally effective "projects" extending endlessly into the future. By contrast, presented here in their proper context are the practical and theoretical precursors to Operation

Clincher, the most successful of all ERE weather engineering operations since 1968. *Clincher* demonstrates an inexpensive, effective answer to the world's smog problems.

Development of the "Flying H"

Development in the mid-1980s, on a high-seas ship, of "Flying H"-type units occurred synchronously with operational divorce-ment from water grounding. Historical photographs on ERE's website of typical Flying H units reveal them as a side-by-side, H-type central mounting of a pair of resonant tubes on a common axle.

Maritime testing of the Flying H began with manual rotation of the tubes, and provided proof of concept. Operations at sea established the need for a small but rugged AC gear motor to provide steady rotation in the frequent high winds of the ship's flying bridge. A powerful modern ship making 22 knots into a 25-knot headwind effectively has a full gale on its flying bridge. This was often the case on SS *Maui*.

Once technical development departed from fixed, multiple-array, rack-type installations and classical Cloudbusters into equipment incorporating rotating components on a motor-driven axle, many new approaches suggested themselves.

Action is the crucible from which new designs emerge. The relative lightness and flexibility of the Flying H units invited mobility. Having these rotating units mounted on a fast ship made it easy—and natural—for such equipment to describe typical spinning wave or *kreiselwelle* forms in the ethers as the ship moved on its gyro-stabilised courses. Tentative new designs could be worked out and then fabricated and tested on site in a pristine environment. Their practical value would be determined experimentally.

The extensive operations that followed development of the Flying H soon showed that radically different equipment designs had moved our infant art into dynamic new domains of action and results.

We had entered the revolutionary era of biogeometric forms as a means of influencing etheric action.

The "Spider" Unit

This new epoch of rotating components soon extended to the development of "Spider"-type units, which were a logical outgrowth of the Flying H. The latter was essentially a horizontally influential device. "Spiders", by contrast, would work by generating vortices in the vertical plane.

Original experiments along this line were carried out with vertical operations using the tested, tried and true "cone guns". These early, waterless derivatives of the original Cloudbuster technology married golden-section metal cones to resonant PVC tube lengths. They were effective, but clumsy and awkward on shipboard in vertical use. Vessel motion added physical hazards. Simplification and stabilisation were achieved by dispensing with the resonant tube section and increasing the number of cones employed. This is how the classic "Spider" units were developed.

Their mode of operation was to direct the apices of the

mechanically rotated cones upward from the ship's deck toward the zenith. Any desired angle from the vertical could be engineered into the design. Infinite adjustment of these angles was provided in some designs. The cones could even be directed horizontally at their minimum adjustment.

The operating theory was based on a known etheric property of the cone: that structure's ability to project a coherent beam of ether from its apex. Many people of even moderate sensitivity can detect this subtle radiation with the palm of a hand. The late, internationally noted dowsing master, Reverend Verne Cameron of California, was able to detect the coherent beam from a cone apex at a distance of several miles. The maximum range of the beam emitted from the cone apex has not yet been established.

Creation and maintenance of the beam "out of nothing", by a geometric form alone, fundamentally challenges conventional concepts. No fuel or power source is required to establish and maintain the beam of etheric energy.

Vortices at Work on the High Seas

A Spider unit, mounting two, four or six cones in a circle around its perimeter, directs that number of subtle beams of etheric force upward, stirring the surrounding, moving ether to encourage vortex formation. The generation of such vortices is continuous as long as the Spider rotates. When the Spider is mounted on a moving ship, its action is greatly enhanced on some courses by the unit's own motion over the surface. Such a functioning Spider will trace the *kreiselwelle*, or spinning wave form(s), in the ether.

Objective effects are undeniable. Chief among these is the ability in totally overcast conditions to tear away this cloud cover above the ship right through to blue sky overhead. The water vapour thus removed from the zenith descends via vortical action to the local horizon in a dense, doughnut-type ring all around the vessel. This cloud ring and the opening torn through to blue sky above move with the vessel over the ocean surface. These effects have been visually observed many times with radar confirmation, and an excellent daylight video example is found in the publicly available videotape, *Etheric Weather Engineering on the High Seas*.

In night-time replications of this technique, radar shows the moving vessel to be surrounded by a ring of highly active rain squalls, about 10 to 12 nautical miles in diameter. This entire rainy system, created by the Spider, moves synchronously across the ocean surface with the ship, sometimes for hours at a time. If the Spider is shut down, the ring of squalls soon dies. In normal operation, as that portion of the ring of squalls being left behind continually fades out astern of the vessel, fresh squalls materialise ahead to maintain the ring around the ship.

The objective reality of these happenings is compelling, especially when they are observed for extended periods as stable phenomena. A video example of this type of activity, at night and on radar, is also found on the video, *Etheric Weather Engineering on the High Seas*.

Implosive vortical action induced by the rotating cones entrains moisture as its contractive force thrusts down toward the ocean

surface. This vortical action reinforces the natural, normal, nocturnal motion of the chemical ether back into the earth from the atmosphere—a daily occurrence that does not produce this patterned activity without the Spider's intervention. Hence the strong rain squalls.

This astonishing activity is brought about with no chemicals of any kind, no electromagnetic radiation, and no electric power beyond that driving the small rotational motor. The overall happening is an evidential avalanche. The chemical ether "speaks" thus, in its own language, a whole new fabric of natural law awaiting mankind's intelligent, cooperative touch.

During this break-in period with the Spider in 1986–87, objective effects were produced on an even greater scale. The North Pacific "high" is more or less a meteorological fixture in that part of the ocean. Millions of square miles are usually involved in this blanket of relatively tranquil, high-pressure atmosphere. Judge our astonishment when, during these vertically active tests, we found that anomalous, sharp little "lows" suddenly started appearing near our positions on faxed US Navy and US National Weather Service

surface analysis maps. The indications were that these strange little systems had migrated from our ship's track and were suddenly appearing in the middle of an almost inconceivably vast mass of high-pressure atmosphere that ruled a million square miles or more. These "implanted" mini-lows were appearing in sufficient strength and size to be observed and reported by surface ships and satellites.

This practical experience of a subtle etheric force that definitely worked physically led to theories as to how this action could be applied to some useful

physical goal or purpose. A practical, beneficial value to humanity would be ideal. Further, wider use of etheric force for human advancement might well ensue.

Experience and Speculation

Linkage already existed in nearly two decades of our shore operations to a modern problem with serious negative impact on humanity: smog.

Our experience since 1968 in southern California had repeatedly demonstrated that etheric rain engineering operations definitely reduced air pollution levels in the region, without any intention to do so on our part. This smog reduction occurred adjunctively to etheric rain engineering operations, whether or not rain was actually produced. A "side effect" is how physicians would describe this smog-reduction capability.

Furthermore, Dr James O. Woods and Trevor J. Constable had on several occasions out of curiosity directed large, water-powered rack units from Thousand Palms Oasis to the west through the Banning Pass and into the Los Angeles Basin. To our stunned astonishment, a heavy stench of smog and auto exhaust pervaded the pristine oasis area within a few minutes. Our action had physically moved smog constituents 50 to 60 miles eastward into the lower Mojave Desert, almost instantly! There was thus a demonstrated technical link between etheric engineering and smog.

This was verified by other, kindred experiences. With the heavy, cumbersome, water-powered equipment we relied on in those times,

Our action had physically moved smog constituents 50 to 60 miles eastward into the lower Mojave Desert, almost instantly!

we could think out no feasible method for pursuing these findings. They were therefore tucked away in our memory banks for a later time. That time arrived with the Spider.

Maritime experience with the Spider had demonstrated convincingly that etheric vortices could be generated from a moving ship by these devices. We already knew there was a connection between the chemical ether and smog. Might it then be possible, perhaps, to generate implosive vortices in the Los Angeles Basin with Spiders operating at fixed bases? An implosive vortex entrains matter within its influence and drives such matter toward the vortex point. In a high-seas format, the matter within its influence was atmospheric water vapour. That is how we saw those rings of squalls surround the SS *Maui* and accompany the ship across the Pacific.

While it was highly unlikely that similar operations from fixed shore bases in the semi-arid southern California area would produce squalls, the generation of milder vortices in such a dry climate might well have a beneficial and cleansing effect on the regional atmosphere around Los Angeles. Etheric vortices engineered there might entrain the airborne particulate matter that is integumented in smog and drive it back to the earth, producing significant air pollution reduction. This seemed worthy of further practical exploration.

In the fixed-based format on land, there would be no reinforcing influence from vessel velocity. We would be dependent entirely upon the native movement of the ether itself, passing through the vicinities of the emplaced Spiders.

We already knew this motion to be continuous, based on the outline of the Earth's ether economy provided by Dr Guenther Wachsmuth in his monumental

Etheric Formative Forces in the Cosmos, Earth and Man. Dr Wilhelm Reich's brilliant pioneering work with Cloudbusters in the 1950s left no doubt about the existence of a west-to-east flow of orgone energy (etheric force) in the northern temperate zone. In the eastern North Pacific, we ourselves had dammed up this west-east flow hundreds of times to engineer rain. We recorded the entire process unequivocally and often on irrefutable time-lapse video. The existence and accessibility of this flow were thus as firmly established with us as our own heartbeats.

A rational expectation, based on our maritime experience, was that vortices stirred into this etheric flow by the action of the Spider(s) would move in strings "downstream" in the ether flow, away from Spider sites. They would possibly influence implosively the physical atmosphere in those regions—east of the Spider sites. In the fashion of vortex behaviour, they could be expected to grow larger and weaker with distance, but would they travel far enough over dry land and have sufficient influence to be physically and statistically evident?

Operation Victor, July 1987

This was the chain of reasoning, theory and experience that brought us to the summer of 1987. Driven by the motto that only results count, we faced the Los Angeles July climate for our test of Spider-type units as smog-inhibiting devices.

Fortuitously, we found ourselves cheek-by-jowl with the most ambitious smog observation, monitoring and study project ever run

by the California authorities, and probably unique in the entire world. This was a comprehensive program organised and funded by the California Air Resources Board in Sacramento, with a budget of US\$10 million. Dozens of smog scientists were brought to southern California from all over the US and from other countries. These professionals were set up in numerous observation and collection bases at key sites in the four-county South Coast Air Quality Management District (AQMD)—the largest and filthiest such district in America.

This was a stroke of good fortune for us. If our humble little project, essentially limited to the month of July, were to be successful, then such a detailed smog monitoring project would show our influence unequivocally. We were elated to know that smog observations of unprecedented detail and complexity would be carried on by the State of California during *Victor*. Were we to fail, then our impotence would show statistically and objectively, and would justify abandonment of such smog operations in future.

Budgeted at a penny-pinching \$4,000, our Operation *Victor* would utilise only three Spider-type stations for the month of July.

The main installation was on Point Fermin, the southernmost tip of Los Angeles, on the Pacific Ocean. A second installation at Tustin, California, was close to the middle of the LA Basin, and the third was at Fort Zinderneuf in Desert Hot Springs on the edge of the Mojave Desert. These stations were equipped with hybrid versions of the evolving Spider, but all three units worked upward to initiate vortices in the ether.

The *Victor* documentation was filed in advance of commencement with the National Oceanographic and Atmospheric Administration of the US federal government.

The scenario that unfolded in southern California in July 1987 strained credulity even among ourselves, poised as we were for positive results. Numerous weather and smog records were broken.

The prototype Spider we had emplaced at Point Fermin produced a drastic reduction in temperatures for most of the month, and the signature of its influence was evident in satellite water vapour photos and 500 millibar charts broadcast on TV and eagerly videotaped by us.

Cold air came rushing down right to Point Fermin from Canada, day after day. The atmosphere in the Los Angeles Basin was crystal clear. Video clips survive in our files of TV weathermen raving about the pristine visibility and clean air, and pointing excitedly to the January-in-July behaviour of the cold Canadian air diving down to Point Fermin, our main operating base.

Smog scientists in the state project were meanwhile struggling to find sufficient smog to justify their US\$10 million presence. There wasn't sufficient smog available for them to gather statistically valid or useful samples. This small army of professional people was accordingly sent home before the end of July. This humiliating abandonment of the smog project was also covered on TV. Compelling proof had been provided, documented by the State of California, that our generation of implosive etheric vortices would indeed reduce southern California smog.

The month of July 1987 stood out for low smog readings within the 1987 season records, while smog overall for the six-month 1987

Dr Wilhelm Reich's brilliant pioneering work with Cloudbusters in the 1950s left no doubt about the existence of a west-to-east flow of orgone energy (etheric force) in the northern temperate zone.

NEWSCIENCE NEWSCIENCE NEWSCIENCE

season took a striking 16.6 per cent drop from 1986, down to a new all-time low!

A significant footnote, with *Victor* concluded in July, was that smog returning with a vengeance in August. The banished smog scientists were then brought back for another study try.

Victor, for us, was an encouraging major triumph. The AQMD smog bureaucracy had received copies of our advance federal filing of *Victor* documentation. They nevertheless palmed off on the media the excuse that this stupendous chain of clean air events was due to "freak meteorological conditions".

Commercial Support for Experiments

Early in 1988, Trevor Constable became associated with a young Singapore entrepreneur and international businessman, Mr George K. C. Wu, now Chairman and CEO of ERE. A multimillionaire with a real sense of adventure, he began working with us to make etheric weather engineering commercially viable.

As an almost ceaseless world traveller, George Wu had firsthand experience of the planetary scourge of smog, and envisioned the commercial potential of an effective and simple method of eradicating this curse. Here was truly a new way, inexpensive and effective. Further development was justified. He subsidised video production, equipment fabrication, transportation and other activity essential to keep the work moving. His intervention was both welcome and timely. The strain of 20 years was beginning to tell on the pioneers.

In the 1988 smog season, we stayed out of the Los Angeles smog scenario. Smog took a large upward seasonal jump,

back to 77 alert days from the *Victor* all-time low of 66 days. This put smog back near to the same level it had reached in 1985 and 1986. Our signature was thus already in the smog statistics and graphs, even as we prepared to impress it there with even greater clarity over the next two seasons.

We continued working on Spider development in 1988–89. Designs were fabricated and tested until we had physically manageable units that were effective in generating etheric vortices.

George Wu had some beautiful examples professionally fabricated in Singapore, and installed them on his office roof. He took some dramatic, 360-degree "fish-eye" photographs of the Singapore skyscape that bore graphic testimony to the tropical power of Spider equipment.

We continued with rain engineering experiments in Hawaii, California, Singapore and on the high seas. With George Wu's counsel and financial help, we decided in 1989 to run a pair of short projects against southern California smog that were within our capabilities and resources. The two operations would together cover three of the six months officially assigned as the smog "season". This would verify the effectiveness of the improved Spiders we were now using, in a challenging practical format.

This was a significant step upward from the July-only Operation *Victor*, but there were human limitations on what we could do. Sufficient personnel were not then available to permit a full-season operation.

We ran Operation *Breakthrough* in July, and Operation *Checker*

in September and October 1989. The seasonal impact of these operations was spectacular. Smog alerts dropped by a stunning 29.4 per cent, all the way down to a seasonal total of 54 alerts—an all-time record, far below even that of the record-smashing *Victor* operation.

This left little doubt that the increased efficiency and improved placement of our new units was responsible for this tremendous drop, since we had only used four stations. Our future in conquering smog looked rosy. Etheric technology could drive this scourge from the Earth!

Planning for Operation *Clincher*

George Wu decided on the basis of the 1989 success that funding an enlarged, full-season smog operation in 1990 was a justified investment. A success to match the previous two might well put etheric weather engineering "over the top" as a commercial venture against smog.

Plans were accordingly made to increase the number of Spider stations. More stations were essential. As the number of alerts was being reduced significantly, reducing them still further would be difficult.

We therefore developed a simple, low-profile, dependable and effective Mark II Spider that could be operated from any secure site that had AC power. The intention was to operate up to 14 stations, if suitable sites could be found and commissioned. All this was arranged by the spring of 1990, and brings the story of *Clincher* to its chronological starting point.

An article titled "Operation *Clincher*" is available from our website. It is an edited version of a special report from the May–June 1991 issue of *The*

Journal of Borderland Research. Compiled by Thomas Brown, then-director of Borderland Sciences Research Foundation and now ERE's distinguished webmaster, this report excluded, for space restrictions necessary at that time, the enlightening technical details in this Internet preface. With the additional information provided here, the reader can grasp that *Clincher* was no fluke or freak occurrence.

Thousands of hours of dedicated labour lay behind the smashing triumph that *Clincher* became, and which it remains to this day, as *the air pollution technology that nobody wants*. ∞

For further information, contact:

Mr George K. C. Wu
Chairman and CEO
Etheric Rain Engineering Pte Ltd
718A Upper Changi Road East, #04-02
Singapore 486850
Telephone: +65 9798 5884
Fax: +65 448 5551
Email: wudefg@singnet.com.sg;
Website: <http://www.ethericrainengineering.info>

(Sources: *Etheric Rain Engineering Pte Ltd* © 1990–2003, updated January 28, 2003, website <http://ethericrainengineering.info>; Ken Adachi's short biography, "Trevor James Constable: A Man of Seasons", at <http://educate-yourself.org/tjc/briefbio.shtml>)

LEE CROCK'S 'AURA THERAPY' / 'ENERGY CLEANER' MACHINE

A simple electronic device, using 'D' cell batteries connected to a wire screen with the body as the floating ground, produces an energy field which, with a polarity switch every 15 minutes, can help the cells eliminate toxins and resolve a range of health problems.

by Jerry W. Decker © 2003

APDO Post 17 CP
Chapala, Jalisco, Mexico 45900

Email: jdecker@keelynet.com
Website: <http://www.keelynet.com>

In my travels and research over the years, I have tried several electronic methods claimed to help the body heal itself. None has given results that were measurable. Of course, no sane person will say outright that their method "cures" anyone for fear of the wrath of the FDA, AMA or local medicos whose regular income depends on your remaining sick.

The machine I want to tell you about first came to my attention through several emails sent to KeelyNet, asking if there was any information about a fellow in Caldwell, Ohio, named Lee Crock, who was using something called "aura therapy" to get amazing results with sick or ailing people with varied conditions, some given up on as beyond hope.

Some of the conditions this machine has been used to help resolve include all types of cancer, Alzheimer's disease, rheumatism, arthritis, kidney, heart and lung failure, hearing loss, various physical pains, headache, epilepsy, Hodgkin's disease, shortness of breath, viral and other conditions, as reported in testimonials seized and on file at the Noble County Courthouse in Caldwell, Ohio.

I had never heard of the guy and didn't actively begin looking into his work until a couple of months later. I ended up calling Mr Crock on several occasions and found him to be charming, personable and very informative about his method. He repeatedly told me he wanted to help as many people as he could, while he could.

After speaking with him several times on the phone and after he sent me a copy of his patent, I wrote up a file about the Crock machine for the KeelyNet website (see <http://www.keelynet.com/biology/crock.htm>). In 2001, we held the first KeelyNet Conference in Dallas, which gave me the opportunity to fly Mr and Mrs Crock to Dallas so he could give a presentation and demonstrate his machines.

The original patent is slightly different than the current machines being sold, as it shows two screens which have now been found unnecessary since the body serves as a "floating ground" for whichever polarity is in effect during a given 15-minute interval—meaning you just need one wire mesh screen, with the body serving to complete the "circuit".

One schooled in formal electronics would think this can't possibly work or do anything useful unless it has a current path. How can a single wire screen, that doesn't even have to make contact with the body, possibly do *anything* to help heal the body? How can there be a circuit path between this screen and the body?

Lee originally thought it was the aura and has taken photographs with a very expensive aura camera which shows the aura changing brightness and colour after exposure to his machine. That is why he called it aura therapy, thinking the screen interferes with the aura of the body to add energy.

It turns out there is an interesting effect called "electroporation", where the cells can be made to expand or contract depending on the polarity of current applied to them. That is what I think is going on in a weak fashion with Lee's machine, possibly occurring as part of a coupling to the aura, or what the Russians call the "bio-plasmic field".

New information has been released recently on work done by the husband and wife team of D. James and Dorothy Morr , who have worked on biological clocks since the 1960s and recently found a 12-minute expansion and a 12-minute rest cycle associated with proteins and cells. This is remarkably close to the 15 minutes Lee found by empirical observation as the optimum time between switching polarities for his machine.

Before the KeelyNet Conference, Lee kindly sent me one of his very early units. The corroded battery plate grids, arranged for 3 volts DC (vdc) output, use of an off-the-shelf AC timer and a single wire output for the pad. There is also a plus-and-minus port to

measure battery power. Lee brought five of the new units to the conference, and he let people examine and use them. These five devices also used the single wire pads, which have proven superior to the dual pads as shown in the original patent.

The machine itself is remarkably simple. It has a combination of 10 'D' cell flashlight batteries connected to produce 3 vdc. A switching relay, set for 15-minute intervals, alternates the polarity (negative or positive) sent to a wire mesh screen made of aluminum and available at any hardware store. This wire screen was held on or near the part of the body to be "treated", though it appears to produce effects as long as it is held within about six inches (approx. 15 cm) of the body, thereby reinforcing the idea that there might be some unknown aura-coupling effect.

HOW THE MACHINE MAY ASSIST HEALING

I would like to bring in some other correlations which might further help to understand how this very simple machine could actually be assisting the body to heal itself.

It is my opinion that the aura of the body produces lines of force which actually "write" the pattern of the aura into the physical matrix of the body. The aura, I believe, changes very slowly and is amenable to "sustained" thought—meaning you can reprogram your aura with concentration and repetition.

According to Dr Harold S. Burr of Yale University, all protein in the body is replaced approximately every 159 days (six months), so why then do we not have a new body each six months? Why do scars and ageing appear in a body that is new? Because the aura *is* the energy pattern which is written into the physical body, and it holds the pattern of the scars and tallies up all the stresses we have encountered over our past, including the prior six months, all written into the flesh of our body.

One interesting claim that correlates

is that of David Hudson who states that monoatomic gold is superconducting and when ingested will add energy to the body, increase psychic abilities and promote healing, among other things. David was with our group in Dallas for several days, giving us the opportunity to spend a lot of time with him. I must say, the man is brilliant, with a mind able to span vast bodies of information and correlate relevant parts. He kindly provided me with copies of two lab reports which showed that new, growing tissue was naturally superconducting—a condition he believes ingestion of monoatomic elements might induce artificially, and a technique he suspects the patriarchs and religious figures knew and used in the past to develop their "powers".

It was from David that I first heard the aura being described as a resultant of superconductivity. A term I like to use in describing the aura, based on David's ideas, is "a dynamic attenuating Meissner field": *dynamic*, because it is living and in slow motion, giving the body time enough to "write" the aura pattern into the reality of flesh; *attenuating*, because it weakens with age and time, eventually becoming so weak that the transcription (copying) of the aura pattern to the body is so weak as to not be able to sustain the energy connection, thus resulting in death; and *Meissner "field"*, because the Meissner effect is experienced with superconductors as a repulsion of magnetic lines of force, no matter the polarity of the magnetic pole. This effect is called

"diamagnetism", when both poles are simultaneously repelled. Scientists in Finland have succeeded in levitating living frogs, fruits and other "non-magnetic" objects in a high density magnetic field, based on this diamagnetic repulsion effect.

Lee Crock's Energy Cleaner Machine requires a "steady state" DC field from the 10 batteries at low voltage (3 volts). Although there is no current flow that I know of or which has been measured between the wire screen and the body or even the aura of a body, I think the energy field from the wire screen attached to the machine provides an ambient pool of force from which the aura can extract energy. I base this suggestion on natural law, where nature always seeks equilibrium, so by immersing a low-potential object into a high-potential field, the low potential object will necessarily be pulled up in trying to come into equilibrium with the high-potential field. Thus, a weak aura or body energy field will be pulled up by absorbing energy from the wire screen via a coupling to the aura.

A similar background energy effect is that observed by Dr Gianni Dotto, who designed and built the famous healing machine known as the "Dotto Ring", which produced an intense magnetic field using 30,000 amps at almost no voltage, making it "almost superconducting"; *ergo*, current without voltage in a super-cold

material has no resistance. According to reports, Dotto's machines would levitate off the floor when in operation, due to the intense magnetic field they produced. This effect resulted from repulsion against the magnetic field lines of the Earth. This claim has caused many to sneer and say it is impossible because the field lines of the Earth's magnetic field aren't that strong.

However, about three to four years ago I received a couple of telephone calls from a young man in Atlanta, Georgia, asking if I knew of a compact power supply that ran on gas or some other replaceable fuel. Well,

yes, I said, there are many power supplies that could fit that requirement, depending on how much power was required to be generated. He then proceeded to say he had built a three-foot spherical model of the Wachspress levitating monopole magnet, connected with a power cable, and which he flew around the room. He wanted to expand this to a six-foot model which would allow for a pilot and needed a self-contained onboard power source. I was impressed by the claim, and he swore it was true and that he could only fly it for about 20 minutes or so before the coils became too hot due to the very high current necessary to drive them, so he risked shorting them out.

This young man was very paranoid and never contacted me again after the two phone calls, so I didn't have a name or any way to contact him. Granted, it could have been a hoax; but he sounded sincere and rather harried, like he was afraid of something.

His machine was based on a magnetic "monopole" which is described in the 1989 patent by Herb Wachspress, describing a toy based on a unique geometry that produced just such a monopole. Basically, it consists of six electromagnets, all pointing with the same polarity towards a centre so as to form a sphere. With sufficiently strong small magnets, you should be able to make a purely "magnet-powered" monopolar sphere. When measured around the surface of the sphere, it would appear as a monopole,

It is my opinion that the aura of the body produces lines of force which actually "write" the pattern of the aura into the physical matrix of the body.

since only one polarity was facing outwards. Using this, Wachspress made a table with electromagnets appropriately positioned and connected to a joystick, so that the magnetic monopolar sphere could be "flown" in the air above the electromagnetic table.

This has no real bearing on the Crock machine or how it works, but I just thought it might be interesting in light of the claims that the Dotto Ring machines levitated off the floor when in operation to produce the 30,000 amps and thus a very intense magnetic field. It would be great to hear from anyone working along these lines, though I don't think I would want to ride in a flying machine with such a strong magnetic field density!

Another interesting correlation to the Crock machine are the "Eeman relaxation screens", sometimes called "bio-circuits" or "Eeman screens". These were discovered by Leon Ernest Eeman in the early 1920s. After serious injuries in a plane crash, Eeman was deemed 100% disabled. While hospitalised, he recalled Jesus' admonition, "Heal the sick by the laying on of hands". Eeman reasoned that this healing energy was the subtle energy of the life force itself. Within two years of his release from hospital, he had developed techniques using these screens that restored him to better health than he had ever known.

These screens are passive devices that facilitate the flow of subtle bodily energy. A scientific, double-blind study, which measured muscle tension and skin conductance as well as monitored EEG, found these screens to be superior for producing relaxation.

LEE'S HEALING PRINCIPLES & TREATMENT PROTOCOLS

After all this preliminary material, now is a good time to repeat what Lee told me on the telephone in our numerous conversations and what he said at the KeelyNet Conference. (By the way, we do have a videotape of Lee speaking at the conference; order from <http://www.keelynet.com/products.htm>.)

Lee said he was fascinated by the "laying on of hands", as reportedly used by Jesus and his disciples and other healers. His healing system stems from Reiki massage therapy, which he says partially relies on the production of heat in the hands to heal the body. The treatment takes from three to five days and is given at his facility, EDK University. At the time of the conference, Lee reported that it has 30 beds and is able to provide treatments around the clock. Those too ill to care for themselves are requested to bring a friend or helper.

Lee says a counter-clockwise (CCW) motion is positive, discharges the cellular electrical energy and relieves pain within about 14 minutes—as opposed to a clockwise (CW) motion which is negative and refills the cells with energy. He describes the principle as like emptying a bucket, filling it back up and emptying it again, over and over, with the idea being to flush out irritants and toxins.

He says an easy demonstration is to hold your hands flat against or close to the ailing organ or body of a subject, and move the palms of your hands in a CCW motion until you begin to feel a

heating effect. Once you achieve the maximum heat, you lay your hands on the area being treated and let them cool down.

A CW motion will recharge the cellular energy, and after about 30 hours of this CCW then CW treatment, repeated in 15-minute intervals, the subject improves. By using a relay of four or more people, doing this technique without the machine, you can continually flush and recharge the damaged cells over 24 hours for three to five days or as needed. The machine Lee has developed apparently produces this same alternate CCW and CW motion without the need of a human operator to produce the same flushing and recharging effect.

One of the side effects is excess urination in people with very serious health issues. Lee says this is due to the body discharging the irritants and toxins that are being released as the tissues are being flushed out via this very simple method.

Lee and his volunteers have worked with over 10,000 people

Lee and his volunteers have worked with over 10,000 people over a three-year period with excellent success rates, he says, with these people coming from all over the USA and at least 10 foreign countries.

over a three-year period with excellent success rates, he says, with these people coming from all over the USA and at least 10 foreign countries. Yet he has been summonsed to appear in court and forced to change the name of his facility from Therapeutic Clinic to Therapeutic Academy (which he has since renamed EDK University due to legal reasons), although he has never claimed outright to be able to heal or cure anything or anyone. His method simply assists the body to heal itself by flushing out the irritants and toxins that cause the problems.

Lee says his electronic device has one wire leading from it, which is connected to a screen that is usually sealed inside a pillow. The pillow can then simply be laid on the suspect organ; the bigger the screen, the greater the area affected.

The CCW motion, Lee says, is like building a coil; and since a coil attracts electricity, this energy coil will pull the electricity out of the cells and carry the toxins with it. He says the proof of this motion is the production of heat in the palms of the hands, which can be felt with or without the machine; and a

less subjective proof is that the subject may tend to urinate frequently when being subjected to this bio-heating and cooling effect.

This sounds to the author like a version of "iontophoresis", where charged ions can be used to introduce or remove elements or chemicals to or from the cells. Once these cellular contaminants are in the bloodstream, they are detected as invaders or excesses and removed as waste, most easily via urination.

And yes, Lee says he has treated himself with the machine for months, where he used a 4 x 8 foot wire mesh screen placed between the mattress and box spring of his bed, with his machine feeding this mesh screen so he would be treated while he slept. He reports that during this process he would have to go to the bathroom four to five times a night, and had to discontinue using the apparatus due to dehydration as a result of his body flushing out irritants and toxins. He adds that it is important to drink lots of fresh water to assist in the flushing. He also mentioned that after discontinuing this nightly treatment, he often still has to

urinate overnight, but the effect is going away over time. I take Lee's comment as a great warning *not to overuse* this technique; use it only when you need it.

Lee provides background information on the basic effect and its discovery, including an "aura therapy" booklet which he gives away freely. He is generous to a fault and charges nothing for people to come to his facility and stay in one of the 30 beds for as long as necessary to get them better. He says he is just there to help whomever he can. Look around and see how rare this kind of attitude is these days. Lee says to give him a call so he can find you an open slot in the schedule. His suggestion impressed me, in that he didn't seem the least bit concerned with selling anything. His main concern is helping as many people as he can while he is here—another sign of excellent character.

I asked if the facility was set up as a non-profit organisation, and he said yes, so they are in a position to accept donations, bequests, etc. However, Lee has an unusual way of selling the machines, using a "lease with option to buy" system. The university where Lee allows people to come and use the Energy Cleaner machines for free does cost money to operate. Many people cannot afford to pay to stay there, so the money has to come from somewhere.

Lee offers a money-back guarantee where he charges US\$3,000 for a machine, which you can use for a month. On receipt of the money, a machine is shipped to you overnight, with the cost of that shipping taken from the \$3,000. If you send the machine back undamaged, you receive the \$3,000 minus the overnight shipping cost. If you decide to keep the machine, the extra money helps to run his clinic and allows those who cannot afford to pay an opportunity to benefit from the machine. In this way, many can benefit from those who buy his machines, so I urge you to consider helping him if you can.

Many people, including myself, have suggested to Lee that he lower the price of the machine and sell many more in volume without the money-back option. This would allow so many more people to benefit. He resists this suggestion, as the system has worked well thus far. The Energy Cleaner Machine can be used for so many problems that many people choose to keep them for their family and friends to use.

RESULTS WITH THE MACHINE

Lee says he has achieved amazing results in treating Alzheimer's disease, because his system helps to flush aluminium from the tissues, as well as arthritis and rheumatism, which resolve as the excess calcium crystals are flushed from the body. He says that in a urine sample of an arthritic person, tiny brown calcium crystals can be seen.

I asked him about muscular dystrophy and other such illnesses, and he says they are nerve disorders, the success of the treatment depending on the degree of decay—though he added that trying it couldn't hurt. Also, since Lee has a great sense of humour, I asked him if the technique helped hair growth or would act like electronic Viagra. He said no, he didn't think it would help restore hair, and he didn't know what Viagra was. I explained it and he said that, well, most of that is in the mind, anyway, so he didn't think it would help...!

One of the other discoveries is that you can have several people touch the pillow while the machine is on, resulting in a greatly increased effect—as if the machine, producing its alternating CCW and CW fields, absorbs additional healing energy from the people participating, which greatly intensifies the healing effect.

This is very similar to the claims of the Eeman screens, where two wire mesh screens are laid next to each other and offset on the floor to be connected with one wire at the top and one wire at the bottom. A healthy person lies on one mesh screen and a sick person lies on the other mesh screen, alongside each other, so that the feet are on the end of each screen. The idea is that a bioelectric current will flow between the two, producing a form of induced empathic, trans-sympathetic healing.

Lee has many great stories about using the machines. One of them has to do with a woman who had lung cancer and was given up to die. In the hospital she was in an oxygen tent to assist her breathing. They thought about ways to smuggle the machine into the hospital to help her.

She was known to be a very religious woman, so they put the device in a suitcase and wrote "anointing oils" on it, then took the pillow and the suitcase in. The pillow was placed on the woman's chest and the single wire was connected to the machine. The helpers all placed their hands on the pillow and put on quite a show when the nurses and doctors came in.

They went back every day and treated the woman for two hours at a time. Within three days she was taken off the oxygen, and within five days she was released to go home. The cancer had "disappeared" and was written off by the doctors as a miracle due to "spontaneous healing".

MY PERSONAL HEALING JOURNEY

I will tell you about my experience with the machine. For some 23 years, I ran the technical support

department in three different photo-finishing labs. During that time I was exposed to chemicals which I blame for damaging my spleen and causing it to become enlarged. The spleen kills off old red blood cells, among other functions, so when it is enlarged it kills off many more red cells than it should, leaving the subject tired and needing sleep. That was my problem.

Having visited five doctors I was sent to a haematologist, who found an enlarged spleen to be the problem. My options were to have it removed and thus become susceptible to opportunistic infections where my only recourse would be to take antibiotics, or take massive doses of cortisone. Either option would eventually damage other organs. Or I could just live with it. I chose to live with being tired and needing more sleep than normal, but I was always looking for something that might help my non-life-threatening condition.

My red cell count when I was first tested was 7.9, and the doctor could not believe I was even walking around. The normal red cell count for a healthy male is 12 to 16, according to the medical staff I consulted. They put me on massive doses of iron and folic acid, which in the next test only increased my count to 8.1. That was the best they could do, and they expressed regret that they could not do more. That was in October 2000.

In the summer of 2001, we had the KeelyNet Conference and

Lee says he has achieved amazing results in treating Alzheimer's disease, because his system helps to flush aluminium from the tissues...

Lee Crock's Alternating Tissue Flush method
(Source: www.keelynet.com/biology/crock.htm)

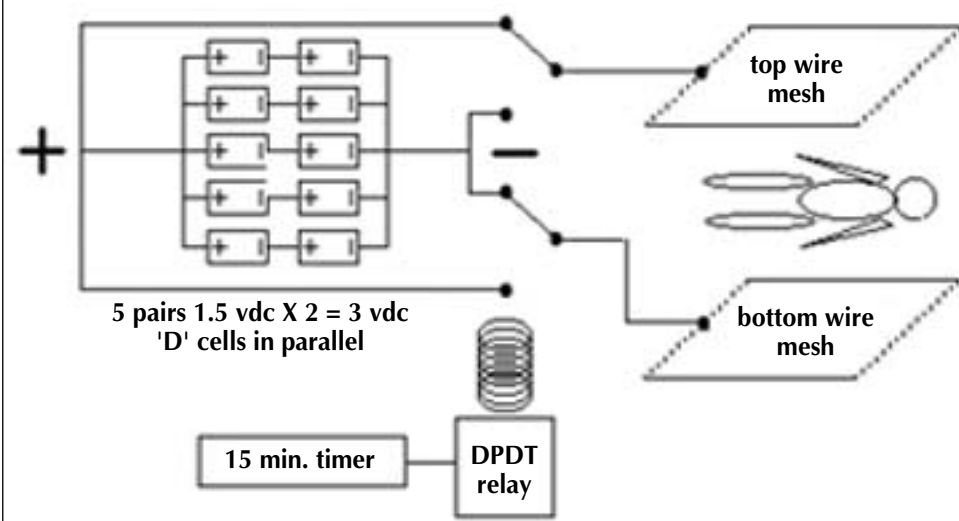

EXPERIMENTING WITH THE "ENERGY CLEANER" MACHINE

The new machines Lee uses necessarily require just nine 'D' cell batteries to get 4.5 vdc and require no outside power, making them completely portable—a much desired feature for many situations and for travel.

These self-contained battery-powered machines are very well built by Mr Tom Berryhill. If you would like to purchase one, email Lee Crock at Energycleaner@aol.com. I recommend that you visit Lee Crock's website at <http://www.edkuniversity.com> and read all the details provided, particularly the testimonials.

Lee lent me one of his machines. I used it for approximately three months, with a 3 x 4 foot aluminium wire screen under my mattress pad and the machine running unnoticed under my bed, all but forgotten.

In the third month, I began having trouble sleeping and would wake up with a lot of energy. I would have to get up to clean the house or do something to dissipate this extra energy so that I could sleep and make it in to work the next day. Finally I realised that the only change I had made recently was to put the Crock machine under my bed, so I disconnected it and over the next two days my sleep pattern was restored.

Around that time, I quit my job for my planned move to Mexico, since the haematologist warned me I was now at risk of sudden heart attack. It scared me pretty badly, so I decided to make a serious life change. Before I left Dallas for my exploratory trip to Mexico, I went back to the haematologist to have another red cell count—and this time it showed 8.9! I had taken *no* iron and *no* folic acid. The doctor and the nurses came to read this result and were amazed, asking me what I had been doing to cause such an increase when their best was 8.1.

I tried to tell them about the Crock machine, but they put their hands over their ears and said they didn't want to hear about any alternative health machine. So much for that. But I made them give me photocopies of the test from the 8.1 (my last best reading under their guidance) and this new 8.9 using *only* the Crock machine.

Needless to say, it certainly gave me faith in the machine. I definitely had more energy, and this test showed why: I simply had more blood. Now I don't know if the machine is helping to increase my red cell production or if it is healing my spleen. To tell you the truth, I don't care—because I feel so much better!

Since moving to central Mexico in November 2001, I have built my own version of the machine, which I call the "MexiStim", and have been using it under my bed with a wire screen under my mattress pad. The machine is on all the time, but sometimes I have to disconnect it because it produces too much energy and prevents me from sleeping.

I have completely changed my diet and lost four pants sizes, which had further benefits for my health. Also adding to my success was not having the temptations of fast food and the stresses of the computer call-centre job that was contributing to my health problems.

In experimenting with the machines, I notice with the 3 vdc system a heat sensation from the pad which I don't experience with the 4.5 vdc system. I thought this was just me, until a fellow in Texas asked me to build him a machine. After he received it, he wrote back saying he had also bought one of the 4.5 vdc systems and had felt heat from the 3 vdc machine but not from the 4.5 vdc. I don't know that this is critical, as people have used and are using the 4.5 vdc system with good results.

My red cell count increased, using one of Lee's newer 4.5 vdc machines, so it apparently doesn't make a difference. A friend resolved her sarcoiditis cancer with the 3 vdc system, as in the MexiStim unit, and this is the design for the machine which I now use for myself.

You can build yourself a machine with some basic ability, but the most difficult part is the timer. Some people use an integrated circuit based on a 555 timer with a big capacitor; others use a 24-hour appliance timer, which I believe gives you 12 cycles which can switch in 15-minute intervals for a total of three hours; yet others do the absolute simplest thing: they hook the wire from the batteries to the screen and watch the clock for 15 minutes; once this has elapsed, they move the wire to the opposite polarity and wait another 15 minutes. All these methods seem to work.

I think it critical to repeat something Lee was quite adamant about at the conference. Lee says to *use only carbon 'D' cell batteries*—not lead acid, not alkaline, not NiCads, not rechargeables and not AC adaptors, because he's tried all of them and didn't get the same feeling in his hands when testing the machine with 10 'D' carbon cell batteries wired for 3 vdc.

We had quite a discussion about carbon being key to life on this planet and why it was that carbon batteries are the best type to use. Was there some kind of sympathetic resonance connection through the carbon connection? This sounds somewhat reminiscent of Edgar Cayce and other bio-energy devices that use carbon. Who knows, it could lead to a new science.

At the conference and in our telephone conversations, Lee also said to use 10 batteries—not nine, not 11, but 10—which they found produces the identical heating and healing sensation he and his fellow practitioners feel in their hands. Since their new portable machine uses nine batteries to produce the 4.5 vdc, perhaps they have changed this recommendation.

Continued on page 74

FROM HELIX TO HOLOGRAM

An Ode on the Human Genome

Life is fundamentally electromagnetic rather than chemical, the DNA blueprint functioning as a biohologram which serves as a guiding matrix for organising physical form.

by Iona Miller and
Richard Alan Miller © 2003

OAK Publishing, Inc.
Oregon, USA

Websites:

<http://www.nwbotanicals.org>
http://www.geocities.com/iona_m

Form is not other than Void; Void is not other than Form.

(from the *Heart Sutra*)

FROM BIOCHEMISTRY TO BIOPHYSICS

What is DNA? Where did it come from? How does it function to create life, to create us? We have some of the biochemical answers, but we can look deeper into biophysics for our models. We propose that DNA functions in a way that correlates with holographic projection. DNA projects a blueprint for the organism that is translated from the electrodynamic to the molecular level. Furthermore, research strongly suggests DNA functions as a biocomputer. This DNA-wave biocomputer reads and writes genetic code and forms holographic pre-images of biostructures. We are more fundamentally electromagnetic rather than chemical beings.

BIOCOSMOLOGY

Where do we come from? Imagine the possibility that life may have come from the fertile womb of the Universe to Earth as a tiny hitchhiking alien, using a meteor as a spacecraft. Anaxagoras, an ancient Greek, first proposed the theory that the seeds of life are spread throughout the Universe.

A science for discovering the foundations of life needs a theory—a biological Big Bang. One current theory has emerged from astrobiology, the science that searches for life in the Universe. It is a candidate to replace the old concept that life arose on Earth in a "primordial soup".

Panspermia alleges that life exists and is distributed uniformly through the Universe in the form of amino acids, microbes, germs and spores. If life arose extraterrestrially, then our planet is *not* a closed system. The fossil evidence shows that life took root on Earth as soon as possible once the heavy bombardment period subsided, the planet cooled and water formed. Vulcanism and space debris made conditions inhospitable to life for the first half-a-billion years of planetary existence.

This "seed of life" can travel between worlds and arrive by natural means such as ballistic impact, meteorite and comet. Intergalactic space may be permeated with cosmic dust and microbes. Evidence shows they could survive the hard-core radiation and the near-absolute cold of deep space. Some researchers (Hoyle and Wickramasinghe, 2000) believe these "seeds" of life are raining down on us all the time, affirming our cosmic ancestry.

Four billion years ago there was no DNA on planet Earth. It is widely believed that our DNA/protein-based cells are derived from an earlier world based on RNA, which can both replicate information and be a catalyst for chemical or metabolic processes. In the prebiotic era, self-assembling RNA was both the genetic and catalytic basis. The simple genome resided in the RNA—a single circular chromosome. We still don't know how RNA arose in the first place (Poole, 1998). Perhaps it arose from some simpler, self-replicating molecule.

The evolutionary path from the RNA world led to the most primitive organisms: prokaryotes (bacteria and archaea) and eukaryotes (single-celled organisms). Neither variety of primitive organism is a complete cell, but even prokaryotes have some free-floating DNA and ribosomes to make protein. Ribosomes "read" the genetic information and make whatever the cell needs. They possibly existed longer than 3.55 billion years ago, as their fossils and carbon deposits may indicate. Even exponents of competing theories on the origin of life agree ribosomes are at least 2.7 billion years old (Copley, 2003). For 500 million years there were only RNA-based organisms. Primitive life could exist in hostile surroundings with extreme heat and acidity or with no oxygen or even light. Latest findings show that this life-form descends deep within the crust of our planet, and perhaps other planets. It seems life is not so fragile after all, but hearty and robust. The womb of our Universe is fertile—not hostile to life.

How life took a quantum leap into the world that eventually manifested human life is still a mystery. To call it life, you need a cell with both a nucleus and a containing membrane. The mystery is written in the cells and molecules of all the life that still surrounds us.

The eukaryotes evolved in complexity, developing cellular characteristics. Arguably, there are fossils 3.8 billion years old that have structural molecules, ribosomes and protein-synthesising machinery. Proteins make possible the molecules for the "blueprint" molecule DNA. The stable DNA molecule became the genome carrier.

SALT OF THE EARTH

We wish to suggest a structure for the salt of deoxyribonucleic acid (DNA). This structure has novel features which are of considerable biological interest.

Thus, Watson and Crick announced their revolutionary discovery with an understatement about their studies on pure, crystallised DNA. But what was the role in the evolution of life for this "salt of the earth"?

A shift to an oxygen-rich atmosphere 2.0 billion years ago allowed the evolution of cells with a nucleus. Eukaryotes keep their DNA structures in a nucleus. They have 10 to 1,000 times more of this genetic substance than prokaryotes. For a thousand million years there were only prokaryotes (microbes) and single-celled microorganisms, eukaryotes. Their reign covers half the timeline of life on Earth.

Cells became more and more complex over aeons, and developed into organs and beings evolved to fuel them. Plants, fish, vertebrae, insects, amphibians, reptiles, mammals, birds and flowers appeared. All animals, insects, plants, fungi and algae are eukaryotes, though the volume of prokaryotes far outnumbers cellular life. Prokaryotes are still essential to sustaining life on the planet. RNA still plays a vital role in cellular life, and hasn't relinquished its primal importance.

Perhaps life did not evolve on Earth at all if it is over 3,850 million years old. Maybe it *did* come in the form of intergalactic organic compounds of extremely hardy bacteria, spores and microbes from space, perhaps safely nestled deep in meteors, comets and planetary debris torn loose in collisions. Once they arrived from space, according to the theory, they self-assembled as proteins, then amino acids and life—with the ability to grow and reproduce.

DNA became the active repository of nature's blueprints for life—a library of proteins. Deoxyribonucleic acid is the molecule that programs our genetic potential. It is a virtually immortal thread tying us to all the life that has ever existed. Decoding life has become a reality, pulling off the veil of nature's mysterious process. Scientists can now purify, amplify and reproduce DNA in the laboratory. They can also overwrite the genetic code to create wholly new organisms.

THE GENETIC ODE

The secret of life! How long mankind has yearned to know its essence and how to extend lifespan and improve health. The discovery of the DNA helix in 1953, by Watson and Crick, revealed the *shape* of this magic molecule. The following 50 years of research has led directly to our ability to read the human genome. We can now decipher its creative *meaning* and imitate its creative evolution.

Genetic engineering is no longer a chimera or sci-fi dream, but a stark reality. In terms of genetics, we are moving from the machine age to the gene age. A flood of new genetic information is transforming science and medicine.

A linear string of nucleotides makes up DNA. It specifies "codons", which in turn specify the amino acids that make up all of the different proteins that combine together to make a body. Five decades of tedious work made it possible to identify the 3.3 billion nucleotides that encode the sequence of the human genome.

Where are we now? It remains to be seen what sort of balance we strike between using the genome for good or ill, or even if we retain our "humanity" and genetic integrity. Humankind has never attempted such a crucial project before. It has often been said that "the map is not the territory", and the same holds true for the "map" of the human genome. Looking at the map doesn't reveal the natural consequences of real-life experimentation. In complex systems, small changes can quickly pump up into dramatic, often unforeseen and potentially catastrophic consequences.

For the time being, the twisted staircase of DNA is explored in the realms of molecular biology and biochemistry. Based on opening this world of biological organisation, we can conjecture what mysteries an even deeper look at the functional basis of living matter might reveal. This is the domain of biophysics, the realm of both particle and wave interactions—fields.

It has been demonstrated that DNA is electrically conductive; much like copper wire, it can carry a charge. It is believed that this live-wire vital capacity may have provided the charge transfer that gave life a jump-start. DNA's ability to transport charge helps minimise genetic damage from oxidation (Lawton, 2003).

The same fundamental physical laws that govern matter and the Universe also govern living organisms. Even a sound biochemical theory can be replaced by an even better, more fundamental, biophysical theory. It is still important to study properties at their own levels, not just as consequences of more fundamental scientific disciplines.

Where are we going? Who knows how future generations of man may be engineered from the 3.3 billion "letters" of the human genome? We have been looking to the genetic *code* for the secret of life. Perhaps we should be listening to the genetic *ode*: the electromagnetic *song* of life that reverberates throughout our being—the audible life-stream.

THE HOLOGRAPHIC UNIVERSE

We are more fundamentally electromagnetic rather than chemical beings. The driver of evolution is not DNA, but even more fundamental quantum mechanical symmetry-breaking forces (King, 2003).

If we drop down another whole domain of observation from the juicy "wetware" described by chemistry and atomic structure, we enter the subatomic realm of quantum physics. At this level the behaviour of matter, both organic and inorganic, is governed not by classical notions of cause and effect or even complex dynamics, but by those of quantum probability.

"Something" appears to emerge from virtually "nothing"—which physicists have come to describe as a "sea of infinite potential". They call it "quantum foam", "vacuum potential" or "zero-point energy"; we can call it the "vacuum substructure". Subatomic particles wink in and out of existence on a continuous basis, like some subatomic froth. This "something" appears paradoxically in wave/particle form. This world is not transcendent to matter, but underlies it as a coherent unity—much like ecology underlies biology.

Within this context, some physicists have strongly suggested that the nature of reality is fundamentally analogous to that of a holographic pro-

It has been demonstrated that DNA is electrically conductive; much like copper wire, it can carry a charge.

jection. The optical process of holography uses interference patterns. Holography describes transformations of light and optical information mathematically in wave mechanics terms. The superposition of a split beam of laser light led to the laboratory development of holograms, or recordable holographic images, demonstrated by Dennis Gabor beginning in 1949. In 1971, Karl Pribram applied this metaphor to neuropsychology, suggesting it was more than analogy and that the brain actually encodes information as holograms. The pattern holds the form.

Holograms contain all the information needed to reconstruct a whole image. They contain many dimensions of information in far less space, like a compressed file. They hold that information in a subtle network of interacting frequencies. Thus, shining a coherent light (reference beam) or laser through the fuzzy-looking overlapping waves of a two-dimensional hologram can create a virtual image of a three-dimensional figure.

The gist of the holographic paradigm is that there is a more fundamental reality. There is an invisible flux not comprised of parts, but an inseparable interconnectedness. The holographic paradigm is one of reciprocal enfolding and unfolding of patterns of information. All potential information about the Universe is holographically encoded in the spectrum of frequency patterns constantly bombarding us.

In this dynamic model there are no "things", just energetic events. This "holoflux" includes the ultimately flowing nature of what is, and all possible forms. All the objects of our world are three-dimensional images formed of standing and moving waves by electromagnetic and nuclear processes. This is the guiding matrix for self-assembly and for manipulating and organising physical reality.

Criss-crossing patterns occur when two or more waves ripple through each other. In the transactional interpretation of quantum physics, waves of probability originate in the past, present and future. Events manifest when waves from past and future interfere with each other in the present. That pattern creates matter and energy. The Universe emerges from the rippling effects of immense numbers of criss-crossing interference waves. The geometry of the fields is more fundamental than the fields or emergent particles themselves.

Our brains mathematically construct "concrete" reality by interpreting frequencies from another dimension. This information realm of meaningful, patterned, primary reality transcends time and space. Thus, the brain is an embedded hologram, interpreting a holographic Universe. All existence consists of embedded holograms within holograms, and their inter-relatedness somehow gives rise to our existence and sensory images.

Interference patterns of waves can be visualised interacting like ripples on a pond. At the quantum level they create matter and energy as we perceive them—lifelike three-dimensional effects. Consciousness and matter share the same essence, differing by degrees of subtlety or density. There is a strong correlation between modulations of the brain's electromagnetic (EM) field and consciousness (Persinger, 1987; McFadden, 2002). The Universe is a continuously evolving, interactively dynamic hologram.

This "Holographic Concept of Reality" was first suggested by Miller, Webb and Dickson in 1973, and later touted by David Bohm (1980), Ken Wilber (1982), Karl Pribram (1991), Michael Talbot (1991) and others. In this holistic theory, the Universe is considered as one dynamic holomovement—a grand Unity.

The part is not only contained within the Whole; the Whole is contained in every part, only in lower resolution. So, following the axiom of "As Above, So Below", we can expect biology to be based on the same physi-

cal foundation of creation. Miller and Webb hypothesised precisely this in "Embryonic Holography", also in 1973. At the time, of course, such notions were untestable. But, with continuing revolutions in technology, now we are closer to modelling and demonstrating this creative process.

DNA AS A HOLOGRAPHIC PROJECTOR

In a hologram, wave fields interfere with one another to lay the foundations for the reconstruction of the image of an object. But how are the wave fields produced? The term "holography" comes from the Greek roots meaning "entire" and "to write". In holography, the image is projected by a coherent light source split into both the object wave and the reference wave background.

This dichotomous nature is reflected in the particle/wave nature of the DNA molecule, which can be "read out" with biophotons from chromosomes to set up a holographically produced wave field. This superposition of wave fields (object wave and reference wave) creates a wave guide for the formation of biological structure. The image is constructed according to the reference information contained in the genes. The reconstructed object wave is identical with the object wave field. The reconstructed wave fields reproduce exactly the recorded ones (the DNA with genetic code).

Russian research in genetics led scientists to begin looking experimentally at the helical structure of DNA as a possible holographic "projector" of the DNA code.

Russian research in genetics led scientists to begin looking experimentally at the helical structure of DNA as a possible holographic "projector" of the DNA code. Thus, the existential blueprint described by the spiral staircase of DNA is translated into a complex EM field that guides the molecular growth of the organism. Miller et al. suggested as much three decades ago, and outlined possible mechanisms of this quantum biohologram at both the cellular and whole organism level.

This process emerges from a domain more fundamental than the standard genetic code triplet model. Biophysics can now describe how our form emerges directly

from the void, the vacuum substructure. In essence, we emerge from the cosmic void—pre-geometrically-structured nothingness. DNA is the projector of that field which sets up the stress gradients in the vacuum substructure to initiate dynamic unfolding. Genes function as holographic memories of the existential blueprint.

At the moment of ovulation there is a definite shift in the electrical fields of the body of a woman. The membrane in the follicle bursts and the egg passes down the Fallopian tube. The sperm is negative with respect to the egg. When the sperm and egg unite, the membrane around the egg becomes hyperpolarised, shutting out other sperm. It is at this moment that the electromagnetic entity is formed. The fertilised egg cell contains all the holistic information necessary to create a complete, operational, human being. The biohologram begins to function at conception and ceases only at death. Our contention is that the DNA at the centre of each cell creates the multi-cellular creature hologram by expressing and projecting the DNA in the centre of the cells.

The biohologram projected by the embryonic nervous system forms a three-dimensional pattern of resonant structures. These structures behave as acoustic waves, acting as field guides for flowing matter and energy. The holograms are "read" by an electromagnetic or acoustic field that carries the gene-wave information beyond the limits of the chromosome structure.

In this new understanding, DNA and the chromosome apparatus is the recording, storing, transducing and transmitting system for genetic information at both material and physical field levels.

THE DNA-WAVE BIOCOMPUTER

The Gariaev group (1994) proposed a theory of the "DNA-wave Biocomputer". They suggest that: (1) there are genetic "texts", similar to the context-dependent texts in human language; (2) the chromosome apparatus acts simultaneously both as a source and receiver of these genetic texts, respectively decoding and encoding them; (3) the chromosome continuum acts like a dynamic holographic grating, which displays or transduces weak laser light and a solitonic electro-acoustic field. In other words, *the code is transformed into physical matter, guided by light and sound signals.*

Complex information can be encoded in EM fields, as we all know from coding and decoding of television and radio signals. Even more complex information can be encoded in holographic images. DNA acts as a holographic projector of acoustic and EM information that contains the informational quintessence of the biohologram. Quantum non-locality of genetic information is fundamental.

The nervous system acts as a coordination mechanism that integrates DNA projection of the rest of the cells in the system, aligning these cellular holograms. The biohologram, projected by the brain, creates standing and moving electromagnetic wave patterns at different frequencies of the spectrum in order to effect different biochemical transformations. There may be specific electrostatic fields, or there may be electrodynamic fields varying at different frequencies, from low (radio waves) all the way up the spectrum into visible light (biophotons) and beyond.

Genes are located on chromosomes in a linear order within the cell nucleus. Chromosomes have the ability to transform their own genetic-sign laser radiation into broadband genetic-sign radio waves (the encoded signal transforms from light to sound). The polarisation of chromosome laser photons is connected non-locally and coherently to polarisations of radio waves.

Through this mechanism, a new field structure is excited from the physical vacuum by an intrinsic creativity that emerges through DNA. The genome's genetic and other regulatory wave information is recorded at the polarisation level of its photons and is non-locally transferred or played out through the entire biosystem by the polarisation code parameter.

Only 3% of the three billion base-pair genome encodes the physical body. The four-letter alphabet of genetic elements—Adenine (A), Cytosine (C), Guanine (G), and Thymine (T) or Uracil (U)—is arranged in three-letter "words" that tell the cell what proteins to manufacture. These genetic characters are distributed in the genetic text in a fractal distribution, i.e., reiterated. So, the nucleotides of DNA molecules are able to form holographic pre-images of biostructures. This process of "reading and writing" the very matter of our being manifests from the genome's associative holographic aspect in conjunction with its quantum non-locality.

Rapid transmission of genetic information and gene expression unite the organism as an holistic entity embedded in the larger Whole. Gene expression is the mechanism by which new patterns are called into being. The system works as a biocomputer—a wave biocomputer.

This biogenesis mirrors the cosmic process of creation. The holographic dynamic underlies both processes of cosmological creation and biogenesis. Chemical bonding is a consequence of the non-linear inverse-square law of electromagnetic charge interaction in space-time. Charge interaction precedes quantum chemistry perturbations of bonding

energetics. Despite being genetically coded, molecules form fractal structures both in their geometry and dynamics. Generating core biochemical pathways gives rise to the fractal structures of proteins, nucleic acids and tissues.

Theories of biogenesis, such as panspermia, are strongly supported by the fact that organic molecules and amino acids, as well as the nucleotides A, U, G and C, have been detected in meteorites. It is a fecund Universe at both the cosmic and human scale.

QUANTUM BIOHOLOGRAPHY

Hypothesis: *The organisation of any biological system is established by a complex electrodynamic field that is, in part, determined by its atomic physicochemical components. These, in part, determine the behaviour and orientation of these components. This dynamic is mediated through wave-based genomes wherein DNA functions as the holographic projector of the psychophysical system—a quantum biohologram.*

In the mid-1980s, physicist Peter Gariaev first noted a DNA phantom effect in his experiments. DNA was bombarded with laser light. When removed physically from the scattering chamber, its electromagnetic signature—a ghostly holographic after-image—apparently remained. What

is measured is light scattering from the DNA phantom fields. As long as the chamber is not disturbed, the effect is measurable for long periods of time. No other substance has been found to emulate the effects of the DNA molecule.

Evidence suggests a relationship to the phenomena of endogenous bioluminescence, liquid crystals and superconductivity. Bioluminescence is the emission of photons of light produced when certain energised electrons drop into a lower or ground state. Humans emit a variety of electromagnetic radiations across the emission spectrum, indicative of the energy state of the organism.

In the nuclei of each cell of the human body, the DNA (deoxyribonucleic acid) carries the structure of our whole body. It is the blueprint not only of our physical form, but also of the processes that our form undergoes in terms of survival. The primal vacuum is the matrix of our existence and, proportionately, our most fundamental reality. In essence, we emerge from pre-geometrically-structured nothingness. DNA is the projector of that field which sets up the stress gradients in the vacuum or quantum foam to initiate the process of embryonic holography.

THE DNA PHANTOM EFFECT

The Gariaev group has discovered a wave-based genome and DNA phantom effect that strongly supports the holographic concept of reality. This main information channel of DNA is the same for both photons and radio waves. Superposed coherent waves of different types in the cells interact to form diffraction patterns. They emerge firstly in the acoustic domain, and secondly in the electromagnetic domain.

DNA seems to embody the capacity to produce a field experienced by other DNA in the body, linking all holistically together. This dynamic is linked to the cellular level via mechanisms of RNA transfer and enzymatic action in the cell. DNA and RNA are likely to be in non-local communication, possible because DNA molecules in chromosomes are in a state of substance-wave duality. So, DNA codes an organism both through DNA matter and by DNA wave sign functions at the laser radiation level. Wave information is recorded at the polarisation level of photons and is non-local. It is transferred throughout the biosystem by the polarisation code parameter, eliciting holistic response patterns.

Humans emit a variety of electromagnetic radiations across the emission spectrum, indicative of the energy state of the organism.

Gariaev claims to have demonstrated subtle fields emerging from the quantum foam or vacuum potential, making the effect quantifiable, measurable and objective. He found the phantom effect by irradiating DNA with a target UV wavelength of 338 nm. Poponin (1995) went on to suggest that some new field structure is being excited from the physical vacuum by an intrinsic ability that emerges through DNA.

Gariaev discovered the DNA phantom effect in 1985 when he worked in correlation spectroscopy of DNA, ribosomes and collagen at the Institute of Physics in the Academy of Sciences of the USSR. He was first able to publish his results in 1991, leading to a book, *Wave-based Genome*, published in 1994. He demonstrated a dynamic new field in the vacuum substructure by bombarding it with coherent laser light and coupling it to conventional electromagnetic fields. The experimental protocols for this procedure have been reproduced in Moscow from ideas developed at Stanford, and are currently in another replication by physicist Louis Malklaka.

YOU TURN ME ON – I'M A RADIO

In analysing any complex adaptive system, we follow what happens to the information; in this case, the genetic information. The quantum hologram is a dynamical translation process between acoustical and optical holograms. DNA and the genome have been identified as active "laser-like" environments. Roughly speaking, DNA can be considered a liquid crystal gel-like state that acts on the incoming light in the manner of a solitonic lattice. A soliton is an ultra-stable wave train that arises in the context of non-linear wave oscillation. Oscillations are set up when DNA acts as a rotary pendulum, kindling other oscillations.

Chromosomes can transform their own genetic-sign laser radiations into broadband genetic-sign radio waves. This is the main information channel of DNA, the same for both photons and radio waves. Superposed coherent waves of different types in the cells interact to form diffraction patterns, first in the acoustic domain and then in the electromagnetic domain. The quantum hologram is the matrix of the translations between acoustical and optical holograms. The human biocomputer can be modelled through the marriage of quantum mechanical and complex dynamics.

Other researchers soon obtained similar results, and not only based on photons. Multi-frequency physical fields are now teleported. Based on this data, it's possible to suppose that photon fields, emitted by chromosomes as sign fields, can be teleported within or even outside the organism's space. The same is true for wave photon fronts, which were read from the chromosome continuum similar to reading from a multiplex hologram. If photons are transformed into radio waves through the EPR-mechanism, then this phenomenon is vital. In fact, the importance of quantum non-locality existence for a genome is hard to overestimate. (Gariaev et al., 2001)

The basic assumptions of Gariaev et al. included the following:

1. The genome has a capacity for quasi-consciousness so that DNA "words" produce and help in the recognition of "semantically meaningful phrases";
2. The DNA of chromosomes controls fundamental programs of life in a dual way: as chemical matrixes and as a source of wave function and holographic memory;

3. Processes in the substance-wave structures of the genome can be observed and registered through the dispersion and absorption of a bipolar laser beam.

QUANTUM TELEPORTATION

The polarisations of chromosome laser photons are connected non-locally and coherently to polarisations of radio waves. The signal can be "read out" without any loss of the essential information in the form of polarised radio waves. The genome is a quasi-hologram of light and radio waves that create the background necessary for the appropriate expression of genetic material. Gariaev argues that the genome emits light and radio waves whose delocalised interference patterns create calibration fields or "blueprints" for a system or organism's space-time organisation, in a coordinated response typical of living systems. Gariaev asserts that quantum non-locality and holography are indispensable to explaining such real-time dynamics properly.

Other research suggests the fundamental interaction of internal and external fields is the right track. Joseph Jacobson (2002) at MIT found a way to switch cells off and on with radio waves. His team also "unzipped" and manipulated DNA with a radio-frequency pulse. The same approach worked on proteins as well, and proteins orchestrate nearly all cellular chemical processes.

Thus, genes can act as quantum objects exhibiting the phenomenon of quantum non-locality/teleportation. This robust dynamic assures information super-redundancy, cohesion and the organism's integrity and thus viability. Gariaev's experiments suggest that DNA does indeed behave like a single quantum, which induces a "hole" temporarily in the vacuum when the DNA sample is physically removed from the vacuum chamber.

Quantum bioholography says that DNA satisfies the principle of computer construction. It carries a copy of itself,

its own blueprint, while the mechanism engineering the DNA replication is the biophotonic electromagnetic field. The "letters" of the genetic texts A, G, C, U are held invariant. The existence of the genetic text constitutes the classical signal process of quantum teleportation. It facilitates the quantum mechanical signal processes of both the copying of the DNA as its own blueprint and the construction and homeostasis of the organism in a massively parallel way by means of quantum teleportation.

So, the marriage of the 50-year-old study of DNA with the 50-year-old science of holography has given birth to the model we call the quantum biohologram.

Gariaev's discovery of the phantom DNA and the DNA-wave biocomputer strongly suggests that this is more than a model but actually the physical mechanism for our appearance from virtually nothing. In one way, you could say we "came out of nowhere".

But here we are, nevertheless. It is solely because of our DNA's ability to transform its genetic blueprint into a physical reality, embodying simultaneously our inherited past and our future. Sure, we can now create *ersatz* life, but we cannot create the fundamental elements from which it arises, which are the gift of the Universe, cooked in giant supernovae aeons ago.

It's like that old joke where the scientist says to God, "We can now make an Adam out of clay", and God says, "No; first you have to make your own dirt!"

Quantum bioholography says that DNA satisfies the principle of computer construction.

Continued on page 76

THE DRAGON SNAKE

A Solomon Islands UFO Mystery

This former RAAF engineer's startling experiences, along with his knowledge of the Solomon Islanders' long history of encounters with strange aerial craft and alien beings, sparked him to search for hidden UFO bases.

by Marius Boirayon © 2003

PO Box 148
Eudlo Qld 4554, Australia

Email:
solomongiants@optusnet.com.au
Websites:
<http://www.solomonsirius.com>
<http://www.thesolomongiants.com>

We had not long returned from the New Georgia group, where I had just bought a beautiful tropical island with white sand beaches and coconut palms, and we were desperately in need of new rental accommodation on Guadalcanal. My best friend Joseph had been helping me find a house that was preferably outside the Honiara area. As there was a shortage of livable housing, it had almost come to the point of taking what we could get.

Joseph told me of a house that he knew of at his village but he thought it wouldn't suit me as I'm a white man. I told him to stop that kind of rubbish thinking and that we should go and have a look. I knew of Joseph's village, but I couldn't place the house that he had been describing to me as we drove the roughly 70-kilometre journey westward along the coast from Honiara.

Upon arriving at Cape Esperance, Joseph pointed to the quaint little three-bedroom timber house that was on the eastern extremity of the village. It had a cement floor and a galvanised iron roof with an out-house near the grass-hut kitchen, and the most beautiful island sea view that anyone could wish for. There was a tap and shower outside with perpetual mountain spring water. It didn't bother me that there was no electricity, as I had a generator. I made up my mind to take the house, as I didn't have too many options left. While I was inspecting the house, the divorced woman who owned the house arrived, and so I formalised an agreement to move in the next day.

Late the next afternoon, we arrived at the house with a six-tonne truck and proceeded to unload all our possessions into the house. This attracted the attention of a good portion of the village folk, as I was the only white man ever to have come to live in their area.

That night, after placing a few fluorescent lights around the house, I started up the generator and sat back with Joseph and a few new friends to relax and have a beer. Later that night, when I was finding out a little more about the area, Joseph told me that I had to watch out for the "Dragon Snake" that was in the area. "Dragon Snake! What ### Dragon Snake?" Just to hear the name of it put a shiver down my spine! They then told me that it comes out of the mountains at night and flies around. They said that the Dragon Snake, with its piercing red eyes, has been feared for generations. It was responsible for people going missing and for killing people.

"What next?" I thought to myself. All I wanted to do was relax and do some fishing in a nice, peaceful, tropical environment. Now I had to contend with some mythological Dragon Snake. I thought no more of it and put it down to one of their superstitions, of which there seemed to be plenty.

MY FIRST UFO SIGHTING

A few days went past as things started to settle down a little. I had become quite an enthusiastic fisherman with my fishing rod, and had been pulling scores of beautiful reef fish. Joseph was renowned by all in the village as being the best spearfisherman. One time he decided to do some night spearfishing, as it was easy to do at night by torchlight. So I decided that while Joseph was spearfishing, I would throw some lines in and see what kind of fish I caught.

I was cleaning fish with Ci-Ci, another good friend of mine, when Joseph came out of the water with his dugout canoe full of fish to add to our already large pile. While we were inspecting his catch, Joseph suddenly shouted for our attention: "There! There! There! The Dragon Snake! The Dragon Snake!" He was pointing to the right, down the beach.

As I looked down the beach, I couldn't believe what I was seeing. About a kilometre away there was a very bright, luminous, white object flying slowly over the water. I remember asking myself whether I was really seeing it. I called out for my wife Miriam to bring my binoculars. After focusing in on the starlike, brilliantly lit object, I noticed that it was about 60-foot round and seemed to make no noise. We watched it for a couple of minutes until it submerged itself into the sea. Joseph told me to wait about 10 minutes and I'd see it come back out again—which it did! When it came back out of the water, it was glowing twice as brightly as when it went in. We continued to watch it with my binoculars as it returned to the coast in the direction whence it had come and until it disappeared out of sight over the top of the coconut trees.

Somewhat startled by this experience, we went back into the house and sat talking about this "Dragon Snake" until the early hours of the morning. They told me that if you didn't see it one night, you were quite likely to see it the next. They were right. In fact, over a seven-month period, I lost count of these sightings when they reached the 60 mark. So while we sat talking about this object, I explained the structure of the Universe to Joseph and Ci-Ci. I showed them my copy of a Time-Life book called *The Universe*, with its space-type pictures, and said that these so-called "Dragon Snakes" are what white men call "Unidentified Flying Objects". They were absolutely amazed, as they had spent their whole life fearing this thing with superstition and having no real understanding of it. Yet, for that matter, I was also a little fearful.

This sighting was the first of well over 60 more to follow, during which time I investigated the UFO waterfall lake base of northwest Guadalcanal and later the UFO bases of the central east coast of Malaita and central Small Malaita. This first sighting, though, had completely changed my mind about the existence of extraterrestrials, and a little investigation revealed that this so-called Dragon Snake had been in the area for well over a century. I realistically began thinking in terms of extraterrestrials inhabiting our planet.

My extensive investigation into the presence of extraterrestrials on Guadalcanal and Malaita has revealed that these supposedly "hidden to the eye" aliens have displayed unacceptable and unfriendly behaviour towards the Guadalcanal and Malaita people; indeed, there have been several outright abductions and murders. Because of this, they can't be considered friendly. For example, the grandfather of a good friend of mine was incinerated by one of these UFOs around the early 1900s. Several independent sources have verified this. Countless horrific stories can be heard throughout these islands.

PLOTTING UFO ACTIVITY ON THE MAP

During the next two weeks, I saw the UFO three more times at the same place as my first sighting. This made me question myself several times as to what I was actually seeing. It also raised many more questions. What was so interesting for the UFO down in the sea where it was submerging all the time? And where did it go when it wasn't flying around?

The part of the sea that was right in front of the village was where the Allied Forces had encountered a Japanese fleet in a great battle that resulted in the biggest loss of Allied ships during any naval engagement in World War II. This battle included the

Australian heavy cruiser, the HMAS *Canberra*, and the American heavy cruiser, the USS *Chicago*. I won't go into the sad details of how they went down, but it was all a tragedy and many men lost their lives. Actually, it would be a really good idea if someone could produce a documentary about it with the submersibles they used in finding and documenting the wreck of the *Titanic*.

A few days later, Joseph and I went to Honiara to obtain a 23-foot fibreglass boat with engine. While we were there, I went to the historical archives to look up information about where these ships had actually sunk. Much to my surprise, I learned that the UFOs were submerging in exactly the same area where the HMAS *Canberra*, the USS *Chicago* and other ships had sunk. This was no mere coincidence, or at least I didn't think so.

At that time, I did not know there were several of these things flying around. Why the UFOs had so much of an interest in these old warships became a somewhat baffling problem for me at the time. I do remember speculating about any remaining gunpowder, but questioned myself as to why these aliens would have a need for mere gunpowder. Somewhat curious as to all these perplexing goings-on and mysteries, while still trying to maintain some form of sanity, I formulated an ingenious plan. And so I went to the nearby Department of Lands and purchased a 1:25,000 topographical map of northwest Guadalcanal.

Meanwhile, Joseph's wife had given birth to a boy, their 10th

child—a remarkable achievement, I thought, for a couple in their late 20s. The child's christening was to be held the following Sunday, and Joseph and his wife had decided to name him after me. It was Joseph's normal job to hold the Sunday mass at the village church. Lord knows why! Joseph was the biggest rascal of them all! On this particular occasion there were five babies to be christened, and so a white Catholic priest from Honiara had been booked to perform the ceremony. I had bought two pigs from the Honiara abattoir especially for this event and

sent an invitation to two chiefs from the area to come to my house for the feast, which was to be held on the grass outside.

The christening ceremony went ahead as planned. The pigs had been butchered and were cooking away in the hot stone oven when the two chiefs and their company arrived. It was quite a large turnout. The Catholic priest from town made a special effort to talk to me and find out what religious denomination I was.

When he'd left, I made my way to the two chiefs and respectfully introduced myself. As we were talking, I brought up the topic of the Dragon Snake. My suspicions were right: the chiefs knew a lot about it. One of the chief's brothers had been killed by it when he was only a little boy. They told me several stories of deaths and abductions, all of which confirmed to me that these UFOs are definitely not friendly. They may be friendly in other places in the world, but certainly not here.

Excusing myself, I went to the house and then returned with my local map and proceeded to ask them where the Dragon Snake's "house" was located. Sure enough, they knew where it was! It took them some time to become familiar with the map and finally agree on what they were looking at. They then pointed out the place to me: an unnamed mountain that makes up part of the mountain range which includes nearby Mount Popori. This unnamed mountain, which for the sake of convenience I eventually named "Mount Dragon", is about eight kilometres inland as the crow flies. They

**My suspicions were right:
the chiefs knew a lot about it.
One of the chief's brothers
had been killed by it when
he was only a little boy.**

told me of a big waterfall high up in the mountain, with a lake beneath into which the water falls. They said that inside that lake is where the Dragon Snake lives! A further study of Mount Dragon revealed that there is a small lake in the mountain that is the beginning of a river. These fellows had no idea of topographical map language, but their descriptions seemed to have some credibility.

If what they told me was true, then it raised more questions. What was at the bottom of this waterfall lake, and how many UFOs were there? I had to stop speculating on answers to these questions, as all of this was starting to sound a lot like a science-fiction movie and I was beginning to question the sanity of what I was doing. On many occasions it crossed my mind to tell somebody—but who was there to tell, and who would believe me? Yet as incredible as this story may seem, all you need do for any proof is go to northwest Guadalcanal and ask a few of the locals. You'd be surprised at what you find out.

CLOSE CALLS AND CULTURAL EVIDENCE

Early one morning, not long afterwards, Joseph came to the house to tell me that a fisherman he knew was in hospital from injuries he had sustained from a UFO two nights previously. He was from a village three kilometres east of ours. After asking Joseph what kind of injuries the fisherman sustained, he told me that apparently he had burns to most of his body. We had all been planning a trip to town, anyway, as Miriam wanted to do some shopping and see her family, so we decided to go to the hospital and visit this fisherman.

After dropping Miriam off in town, Joseph and I went to the hospital. Following some enquiries as to where the fisherman was, we arrived at his bedside. He was covered in bandages from head to toe and was in a great deal of pain, but doped up with pethidine. Joseph began to speak with him in the Guadalcanal language to try to find out exactly what had happened to him.

He had been out fishing in his fibreglass boat at about 3.00 am, when he saw the Dragon Snake flying along. In foolishness, he started flashing his torch at it. That was when it flew over to him in an instant and hovered overhead. Panicking, he started the motor and took off to get away from the Dragon Snake, but it followed him as he "zigzagged" his way back to shore. It was during this short pursuit to the beach that it fired some form of light at him but it only partially hit him. A later inspection of his 19-foot fibreglass boat showed traces of scorching upon some of the boat's interior paint.

He said that when he drove his boat up the beach and ran into the bush, the Dragon Snake followed him to where he was hiding behind a tree and hovered above. When he moved around to the other side of the tree, it also went around to the other side. It was then that he literally got down on his knees and began to pray to God with his hands clasped in front of him. With that, the Dragon Snake moved on. After that, he stumbled his way back to his village and was taken to hospital.

It was an incredible story, but true. He definitely had no reason to be lying. These kinds of UFO encounters have happened on numerous occasions over the past century but, strangely enough, the Solomons being the way they are, reports have not been taken seriously.

After leaving the hospital, we went over to my in-laws' house to pick up Miriam. I began discussing the matter of the so-called Dragon Snake with my father-in-law, John, and explained how some of the white men believe that aliens from other worlds are the ones responsible for driving this type of flying vehicle. When I explained to John what they were commonly thought to look like—four-foot tall with big head, big eyes, four fingers, transparent skin, etc.—he told me there was a book in the Solomon Islands Cultural Museum with pictures describing this sort of being. Somewhat surprised, I asked John if we could duck into town so that he might show me this book, which he agreed to do.

Upon arriving at the museum and after a few directions to this book, there it was! This 15-page book had 14 detailed hand-drawn sketches of aliens just like the ones we are all used to seeing on television. An islander had compiled this short collection of drawings for the museum from different eyewitness accounts of these strange-looking creatures. There was an initial descriptive verse saying that the drawings were of some Solomon Islands mythological beings. What I wanted to know was: how could the Solomon Islanders know anything about these kinds of aliens, when 99.9 per cent of them had never had any significant type of exposure to white man's media? Most of the old tribal people still thought that the stars were caused by pinpricks in the sky and that the Earth was flat, so how could these pictures of alien types be explained? At the

time, this became another little baffling mystery to me.

We picked up Miriam and on the drive back home I asked Joseph to tell me about the time when he, Ci-Ci and his brother Ben had encountered the UFO while out fishing. He said that the three of them were in their dugouts at about midnight when they saw the UFO. Initially, they were each separated by about 50 metres. As if curious about each of the fishermen, the UFO hovered over each of them for a minute and then departed at incredible speed toward the island of Santa

Isabel. By the time all three had finally reached shore, they were spread out over a kilometre's distance along the beach. Although Joseph described the story as being funny, there was a serious side to it.

REALITY SINKS IN

During the following weeks, I pondered on all of the previous weeks' happenings. I realised that I was most probably the first human being to have been in the position to have experienced all these phenomena, and was able to understand the significance of the unique circumstances in which I had found myself.

I was the first person in the area who'd ever realised the similarities between UFOs and these Dragon Snakes. Also, to my knowledge, I must have been the first white man to speculate on the possible location of a hidden Dragon Snake/UFO base—though I needed to do further investigation to confirm my suspicions. These kinds of unusual realisations were starting to take their toll on my keen sense of logic, but the reality of it all was that these unexpected events had actually occurred. Prior to these sightings, I was somewhat sceptical about the existence of UFOs—but my position had now dramatically changed.

I also realised the possible consequences of investigating this matter any further. Some of these were very positive, but some were also extremely negative. One of these negatives was the

As if curious about each of the fishermen, the UFO hovered over each of them for a minute and then departed at incredible speed toward the island of Santa Isabel.

impact on my precious well-being. I had initially only gone to the Solomons to enjoy an early, youthful retirement and certainly had not expected to be chasing UFOs. But as a former military man, I couldn't stop thinking about the fact that this UFO was continually coming and going near ships that had been involved in a great battle where thousands of men had lost their lives in the cause of freedom. It seemed as if this UFO was robbing graves. This weighed heavily on my mind for weeks.

One night, though, while I was sitting fishing, my indecision changed. I had been watching the UFO submerge into the sea near the wreck of the USS *Chicago* and then surface again shining more brightly. I had my binoculars fixed well on it when I saw the lights of a ship that was travelling toward my direction. From the trigonometric perspective, the UFO couldn't see the ship because of the point that was shielding its view. However, I had both the UFO and the ship in my field of view. After about 30 seconds, when the UFO *did* see the ship it instantly vanished. The UFO didn't seem to go anywhere; it simply vanished as if it had turned off its lights. I took my binoculars from my eyes. I was not sure if the craft had instantly accelerated or had somehow cloaked itself. Yet it seemed that the UFO didn't mind the indigenous people seeing it, but it *did* mind when someone saw it who would possibly know of its real identity. If there's one thing I hate, it's sneakiness!

In any case, I made up my mind right then and there to gather intelligence on this so-called Dragon Snake by doing some reconnaissance on its movements. Switching into soldier mode, I went to sleep formulating my plan.

My subsequent investigation into the UFO's ability to cloak itself revealed that this characteristic was commonly known by all within the area and had become part of the superstition about the Dragon Snake. There are just too many stories about the Dragon Snake's sudden "disappearance" to discuss here.

EXPEDITION TO MOUNT DRAGON

The next morning I went up to Joseph's house to tell him of my plan. My intention was to place ourselves at night, high up in a panoramic position so that we could familiarise ourselves with the UFO's movements. With the map out, we began to study the area for possible positions.

From where "Mount Dragon" was situated, there was really only one way to the coast that the UFO could take without being detected flying over mountains. That was via a five-kilometre-long valley that runs in a northward direction past Mount Dragon. Earlier discussions with some of the people living a few kilometres east in that direction had well confirmed this to me. After searching the area for a suitable position that afternoon, we chose an accessible 800-foot mountain that had all the requirements we needed. And so we went home to prepare for what was becoming a military mission for me.

The next day, we gathered all the equipment we thought was required. I also loaded my 30-shot, 7.62-mm and my shotgun to take along just in case. There was also the danger of being gored by wild pigs, of which there was no shortage. My wife became

quite agitated by my actions, and a heated discussion followed.

Joseph and I left at 8.00 pm to travel to our vantage position. We knew that the UFO had the habit of appearing at around 10.00 pm or 3.00 am. After parking the car in the bush, with torchlights shining we climbed up to the top of the mountain. This turned out to be a perfect position as we had a 270-degree view of the area. Because of the orientation of the mountain, we faced east. With a clear view of the sea to the left of us and the valley's entrance to the right, there was no way that we were going to miss seeing the UFO when it made its appearance—and we didn't.

Having sat up half the night, watching and waiting and having a few beers to pass the time, at 2.35 am we saw the first glimmer of the UFO's light leaving the valley's entrance. There was an air of excitement between me and Joseph. While training my binoculars on the UFO, I noticed that it was travelling toward our direction at a fair rate of speed, which we estimated later to be about 100 knots. We had been watching it approach us for close on a minute when it came past at an estimated height of 300 feet, half a kilometre away. No sooner had this UFO passed by than it took an instantaneous 45-degree turn to the left and then accelerated away at phenomenal speed. I took the binoculars from my eyes, and we watched the UFO's light diminishing over the horizon within seconds while it was still travelling at near sea level.

This whole episode was a mind-fathoming experience, even when I think back on it today, seven years later.

All our efforts had paid off. This sighting confirmed to me the information that I needed to know. This UFO definitely *did* come from somewhere up that valley! This was the first time that the information the two chiefs had given me had started to be proved correct.

At that time, there was only one other course of action left for me: I had to make an expedition up the valley to Mount Dragon and try to document this UFO on film. I was extremely under-funded for

the manner in which I wanted the expedition to proceed, as most of my money was tied up in essential assets and I had been living off my fortnightly military pension. Even though I had most of the equipment necessary to commence, I was still short of a good video camera that could take pictures at night. I had a Kodak Instamatic, but it was useless for night work and certainly was not the calibre of camera that I required for this job. I was in a catch-22 situation. I couldn't borrow a camera; there was only one white man I knew well enough to ask, and he didn't have a video camera, anyway. As the weeks went past, every time I saw the UFO I became progressively more frustrated about my video camera situation.

One morning at 3.00 am, a couple of weeks later, Joseph and I were on the grass outside the house, husking coconuts around a fire, when we noticed the UFO. As we watched it, we observed that it was slowly moving in our direction. It started to get closer and closer, and it seemed to us that if it continued on the path it was on it would overfly us. As it progressively came even closer, we started to move to the door of the house. Both Joseph and I were standing at the door when it flew over the nearby trees and over the top of the house. The brilliance of its white light radiated the whole area as if we were standing amidst the light of a dozen arc welders

We had been watching it approach us for close on a minute when it came past at an estimated height of 300 feet, half a kilometre away. No sooner had this UFO passed by than it took an instantaneous 45-degree turn to the left and then accelerated away at phenomenal speed.

at once. This was the first time that I could clearly see the vehicle's sphere with my naked eye. It made no noise as it eerily passed over us. In fact, at the time we made audible comments to each other about what was happening. After it went by, we both ran out to see it disappearing over the trees further on. Joseph had experienced this sort of thing before, but I hadn't.

After the reality of what had happened sank in, Joseph and I decided that we would go to Mount Dragon—with video camera or not. It was in my mind to confirm whether this mountain waterfall lake was really the UFO's base.

Around that time, a melancholy feeling of futile inadequacy and powerlessness started to dominate my thoughts, as though I was carrying around a heavy weight on my shoulders. This was due to my constant questioning of the reality of it all, and also because I allowed my thoughts to be weathered down because of my desperate need for a good-quality camera. I could not explain this to anyone, as there was no one I could explain it to who could understand. It was like being lonely amongst a crowd of a thousand people. I went through a time of considerable self-examination.

Strangely, I remember thinking to myself that if I ever happened to write all of this down one day, I should remember that particular time...

SUBTERRANEAN UFO BASES ON MALAITA

I would like to share some significant further research from my expeditions to Malaita in 1996, 1997 and 2002. Contrary to popular belief, NASA—or whoever that mob was—first made contact with the occupants of the subterranean UFO base in central east Malaita in 1961. This is how they began to gain what partial technology they have today. It was through blackmail. This happened because when the great geologist Mr Gropher was doing his few expeditions in the area between 1958 and 1960, he saw these UFOs and then reported back to the UK (the ruling colonial power at the time) about them.

Apparently, in 1961, a white man who claimed to be from NASA came to that part of the island and asked for assistance from my wife's relatives to take him to the UFO subterranean base entrances, which they did. I am the only white man ever to have married a woman from Kwaio, which is in that area. This NASA guy was gone a week and then returned, asking my wife's relatives for further assistance to take him back to these places.

There is a 50-metre-diameter, bottomless circular reef in amongst the surrounding 10-metre-deep coral reef a few miles north of Kwoi Island (which is on the border of the Kwaio and Kwara'ae tribes) and south of Namore'ere in central east Malaita. Singalangu Harbour is slightly further south. UFOs can be seen going in and out of that reef virtually every night.

My friends like fishing down this UFO hole during the daytime because it saves them from having to go out into the danger of the ocean and because there's a plentiful supply of big ocean-type fish that can be caught in its depths. They have let down over 200 metres of 100-pound line and still haven't been able to hit the bottom. I always think of this hole as having been made by a huge spaceship that hovered above it and shot a big laser into the crust of the Earth, for whatever reason!

On mainland Malaita, about three to four miles directly inland from that circular reef entrance is a lake which has two connected

entrances/exits. When the boys are out fishing at night, they see the UFOs going in one entrance and coming out the other. A UFO coming out of this lake at dusk incinerated my good friend's grandfather, and everyone in the area knows about it. The aliens have instilled fear in these people for generations, and many people have gone missing.

In the Kwaio and Kwara'ae areas, there are three entrances in their jungle mountains that I know of where these "ball of light"-type UFO vehicles can be seen entering and exiting. It is my belief that these entrances are not individual bases but are all connected, making up one big UFO base under the island. I may be wrong, but I also believe that one of the many reasons why they are there is that, for reasons of their own, they are mining a very rare type of gemstone under this kimberlite rock volcanic island.

The gemstones which my wife's relatives possess have a far higher specific gravity than that of diamonds, and a refractive index such that when you put the stone in light you see your mirror image in the centre of the stone. I once had a 32.4 carat "ET stone" with these characteristics. There are some old folklore stories supporting the interest in these unique stones.

Furthermore, as there are many remnants of the Ramo civilisation that can be found on top of the island and the aliens underneath, there is every chance there is a connection. And that goes for on Guadalcanal, too.

The waterfall lake UFO base of Small Malaita (south Malaita), where I have also witnessed their activities, is easy to find. Just ask the locals, but,

heading north up the passage with Small Malaita on your right, about three kilometres from Affiou, the main town, and about a kilometre up the jungle mountain is their base entrance, where they can be seen entering and exiting nearly every night and also brazenly and casually flying along the passage.

Many Solomon Islanders have told me of flat stingray-type UFOs with big round lights underneath them that hum as they go along. They sometimes see them flying low over the jungle and surfacing out of the sea near where they are fishing. The UFOs have landed near villages, and the (white or black) people who get out of them have strange grey uniforms, not seen anywhere else in the world. You can make your own deductions there.

Nevertheless, if there were ever a place that one could call "UFO Headquarters", it would have to be central Malaita. Mind you, these are only the ones I know of. Goodness knows what else there is in the rest of the Solomon Islands. ∞

About the Author:

Australian Marius Boirayon is the son of the World War II central France *maquis* (resistance) leader, and grew up in Mount Hagen in the Papua New Guinea Highlands. Following a career in the Royal Australian Air Force and as an aircraft/helicopter engineer working in outback Australia, he decided in 1995 to go to the Solomon Islands to live.

Marius Boirayon is raising funds for an expedition to the Solomon Islands to investigate UFO and other mysteries (see his article on the Giant Races of the Solomon Islands in Twilight Zone this issue). He can be contacted by mail at PO Box 148, Eudlo, Qld 4554, Australia, by email at solomongiants@optusnet.com.au, or via the websites <http://www.solomonsirius.com> or <http://www.thesolomongiants.com>.

**...if there were ever a place
that one could call
"UFO Headquarters",
it would have to be
central Malaita.**



GIANT RACES STILL EXIST IN THE SOLOMON ISLANDS

by Marius Boirayon © 2003

Science is a progression of discoveries, and this is definitely one of the bigger ones that we will have for a while. I'll get into some facts about the Giants of the Solomon Islands by using the Giants of Guadalcanal first as an example.

The Giants of Guadalcanal live inside the huge tropical rainforest jungle mountain ranges of Guadalcanal. They have vast cave systems running the length of the entire island. I have come across many Guadalcanal people who believe these Giants can go from east to west through these cave systems without seeing the light of day, and many believe that their population numbers in the thousands.

The Guadalcanal Islanders also believe there is a huge city of them underneath the big mountains of the island. Mount Tatuva is definitely one of this city's main entrances; and if anyone ever wished to film these Giants, the villages closest to the mountain, where they are also seen regularly, is a good starting point. But that is not required, because they are all over the place and are seen on a daily basis somewhere on the island.

To my understanding, there are three different species or types of these Giants. The

larger and more commonly seen are over 10 feet tall, but I have come across numerous islander accounts with evidence which supports that they grow much taller than that. These Giants have very long brown or reddish hair, and when they want to have a good look at you they pull it aside from their face with one hand. They have a protruding double eyebrow, bulging red eyeballs, a flat nose and a wide-gapped mouth. From the large hairy type, they range down in size with lessening amounts of body hair. The smaller versions, although bigger than normal human beings, are like wild men living in the jungle and are not as hairy as the big ones. This is the way the Guadalcanal Islanders describe them. Invariably when they see these small Giant, half-human people, they make efforts to kill them. These smaller versions are lower down in the Giants' social order, living predominately outside their cave systems in the jungle, although all three types are found in the island's jungle.

I must point out that the Solomon Islanders don't understand that the Giants are something big to the rest of the world. Whether by intentional design or not, it is appropriate that the Solomon Islands' slogan is "The Place That Time Forgot".

Guadalcanal is rich in gold—a fact that the Europeans discovered centuries ago. Thirty years ago, various gold mining

companies started negotiating with the traditional landowners with memoranda of understanding in order to capitalise on this gold. A succession of failed attempts followed, until recent years when Ross Mining broke through with a 3% deal for the indigenous people.

In 1998, at Gold Ridge in central northern Guadalcanal where the mine was being built, they got going with their bigger type of mining bulldozers pushing in roads and clearing the mine area. The mine borders the Giants' territory, and it would appear that the Giants are quite territorial. On one particular occasion, one of these huge bulldozers broke down, with one of the pins on the blade attachment rendered useless. As it was late in the afternoon, they decided to drop the blade there and take the bulldozer back to the workshop to do the repairs overnight so they could continue the next day.

When they returned the next morning, the blade had disappeared. All the boys became confused. How could such a heavy object vanish? Mind you, we're talking about 10 tonnes plus! So they started scouting around in the bush and happened to notice gigantic footprints, around three feet in length, close by where they'd left the blade. They found the blade some 100 metres away on a small hill. From further footprint investigation, they deduced that

the Giants had not carried it there but had thrown it, or had got it there some other way.

Some years ago, as a retired helicopter pilot/engineer I was asked by the chief helicopter pilot of an American fishing fleet which had helicopters to look after their spare parts requirements, as Australia is closer to the Solomons than Guam. The job lasted six weeks and I was handsomely paid for my little effort.

The office I set up was just opposite the old Guadalcanal provincial headquarters, and at lunchtime I would sometimes go across the road and have a few beers there with the then Guadalcanal Premier and the Finance Minister, Victor. It was during one of these lunchtimes that they told me of an encounter with Giants that they'd had some months beforehand. Both the Premier, who is now a national minister, and Victor, who is again a Guadalcanal minister, had decided to go to Gold Ridge to survey the area of the proposed gold mine. In mid-afternoon they got into their twin-cab Toyota Hilux and drove up there.

It's quite a drive, and after passing a few villages on the way they arrived at the mine area. A bulldozer had carved out a road, but, as it rains frequently, the road around the side of a hill had become slippery and the Hilux slipped off the road's edge and became bogged. They made some effort to get the 4WD vehicle back up onto the road, but then decided to walk back to the last village they had passed and get a bunch of boys to come and help them pull it out.

Obtaining 30-odd men, they walked back. As they were rounding the last corner from where the 4WD was bogged, they saw their vehicle back up on the road with two huge Giants standing there, one in front of it and other behind. The first reaction for all of them was to run away, screaming in absolute fear. They told me that when they got the courage up some half-hour later, they returned to find the Giants had left.

I asked how tall the Giants were. They told me that the taller of the two was the one that had lifted the front of the vehicle up onto the road. They said that when they inspected the footprints, they could see that each Giant had picked up the vehicle by putting one foot on the road and the other near the vehicle. Pointing out through the

window to a tree, the Premier said, "About that high"—which I estimated to be over 15 feet and which would be consistent with the 3–4-foot-long footprints they had described.

Apes and monkeys cannot breed with *Homo sapiens*. So where do I think the Giants came from? I believe they are a surviving species of hominoid that had branched off well before Neanderthal man and developed through evolution to be what they are today. The Guadalcanal people also believe that the Giants were there before they were. Apparently their gene pool allows them to breed with the local people.

Why are they so secretive and universally so shy about being seen or known about? I'm sure that within the

Ezekiel Alebua, a once Prime Minister and the previous Guadalcanal Premier, told me of a burial cave in east Guadalcanal that his father took him to when he was a child. Within that cave, there is a perfect Giant skeleton laid out that is around 15 feet in length.

next decade we'll find out the answer to this question.

It is my belief that the reason why the Solomon Islanders' population is far smaller than it should be is because the Giants of the islands considered the local people as food to be eaten.

Eyewitnesses who have been captured and released have told me that it is just like daytime inside the mountains. There is a lighting system within the Giants' cave dwellings that has no obvious light source, such as bulbs and lamps.

Guadalcanal and Malaita have literally hundreds of caves with Giant artefacts within. Ezekiel Alebua, a once Prime Minister and the previous Guadalcanal Premier, told me of a burial cave in east Guadalcanal that his father took him to when he was a child. Within that cave, there is a perfect Giant skeleton laid out that must be around 15 feet in length.

Luti Mikode is well known by the people around Guadalcanal as "the Chief of the Giants". The story about how he changed the Giants' attitude about eating the Guadalcanal people about a century ago is just extraordinary. Luti Mikode's education of the Giants—to the effect that the Guadalcanal people had hearts, minds and feelings like themselves, and were not to be eaten—resulted in inter-clan wars amongst the Giants. I have recorded this widely known and most fascinating story and have proven it to be true.

The Guadalcanal people's language and the Fijian language are very close. There are over a hundred words in common, meaning that a Guadalcanal person can go to Fiji and speak Fijian within a week and vice versa (as my good friend and partner Peter Casi found out when he and his band of musicians did a tour there).

The Guadalcanal Giants' language is very similar to the dialect of the Guadalcanal people.

It is well known that Giants do not like fire, possibly because of their long hair. Some months ago, Ezekiel Alebua told me of an incident that happened on the Weathercoast, south Guadalcanal, in 2000 during the tension.

Five Tangarare men had gone hunting pig with their bows and arrows, and during their hunt they lost track of time. As it was getting late and the weather was ominously turning to rain, they decided to build a sago palm hut quickly and camp the night. They were sitting around a fire within the hut, with the rain pelting down outside, when a huge hand and arm came through the hut's wall. An inquisitive Giant had leaned over the hut and was feeling around for what was inside. The five men started screaming and using sticks from the fire to beat the monstrous hand away. Horrified, they ran straight through the back wall of the hut, into the darkness of the bush. When they found each other the next morning down on the coast, they realised they had dispersed several kilometres apart.

There is a World War II mystery that has never been solved about why initially there were no Japanese to resist the Allied Forces at Red Beach and Henderson Airfield. This was uncharacteristic of the Japanese who, on other island campaigns, had always fought to the very last. When the

Allied Forces arrived, they were expecting to lose one in two men, but instead there was no one to be found.

At The Borderline, very near Mount Austin, further up the road past the Japanese Memorial there are three Guadalcanal tribes. The Simba is one of those tribes, and living not far from them is an old Giant couple, a male and a female. Any of the tribes up that way will tell you all about them; it's common knowledge.

The area is rich with many stories pertaining to the local tribes' tumultuous historical relationship with the Giants, but so is everywhere else on Guadalcanal and, for that matter, everywhere else in the Solomon Islands.

The Giants inhabit all the larger islands of the Solomons, but they are known by different names on each of these islands. However, "Moo-Moo" (like the cow noise) is the universal Solomon Islander name for these huge people.

Choiseul, an island 300 kilometres long by 80 kilometres wide at the western extremity of the Solomons, apparently has just as many Giant people as Guadalcanal has living in its interior. When you observe the map, you'll notice there is not one village in the interior of Choiseul—and there is a very good reason for that.

The island of Santa Isabel has big Giants still living there in two different areas, but their population is far fewer than that of Guadalcanal. Central northeast and central north are the two areas where they can be found on that island, but just ask anyone there and they will steer you in the right direction.

Makira, which is east of Guadalcanal, has only the small, super-strong dwarf-like Giants, which can also be found on Guadalcanal. In 1996, there was a front-page picture of one of these four-foot "Chowa-Chowa" in the *Solomons Star* newspaper.

Malaita has a very rich history with these giant people. The Ramo of Malaita are the same as the Giants of Guadalcanal, although reportedly culturally different.

There is also evidence of a lost South West Pacific civilisation scattered across different parts of Malaita. Around a mountain near Mount Mala in north Malaita's interior is a perfectly fitted large stone block wall and path spiralling around the mountain. This path leads to a flat area on top of the mountain, where another large stone block wall separates to a higher split-level flat area where an "altar" can be found. Some hundred metres further on is a burial site that has a perfectly flat, approximately 18 x 6 x 1-foot stone upon it. The bush people further away from that area say that a Ramo of great importance is buried there. There are also hieroglyphic inscriptions chiselled into these stone block walls.

In Kwaio, a place where my wife is from, obelisks with strange inscriptions upon them can be found deep in the bush. In an area of Kwara'ae, north of Kwaio, there is a large burial place in the jungle with thousands of Giant Ramo skeleton bones scattered upon the ground. A hut in one village not far from this area has as one of its main support poles a Ramo femur bone measuring nearly eight feet in length!

On Guadalcanal, the Giants are common knowledge to all of the local people, and due to past interactions they play a major part in the history, culture and folklore of the people. The Guadalcanal Giants can

be found in the 1,000-square-kilometre area of tropical jungle mountains west of Mount Popomanaseu.

It is my dream that one day soon these remarkable people will be recognised and that we may all benefit from the knowledge. ∞

About the Author:

Marius Boirayon was born in Australia and raised from the age of five in the Highlands of Papua New Guinea. He completed his senior education in Queensland and then joined the Royal Australian Air Force (RAAF). After service in the RAAF, he spent some years working for various companies flying mainly in the outback of Australia as an aeroplane/helicopter pilot engineer. In 1995, he decided to go to the Solomon Islands to live.

Marius is currently in Australia raising funds for an expedition to the Solomon Islands. Interested persons can contact him by mail at PO Box 148, Eudlo, Qld 4554, Australia, by email at solomongiants@optusnet.com.au, or via the websites <http://www.solomonsirius.com> or <http://www.thesolomongiants.com>; alternatively, they can contact his colleague John Mapson by email at mapsun@bigpond.com.au.

Marius Boirayon's article, "The Dragon Snake: A Solomon Islands UFO Mystery", is also published in this issue.

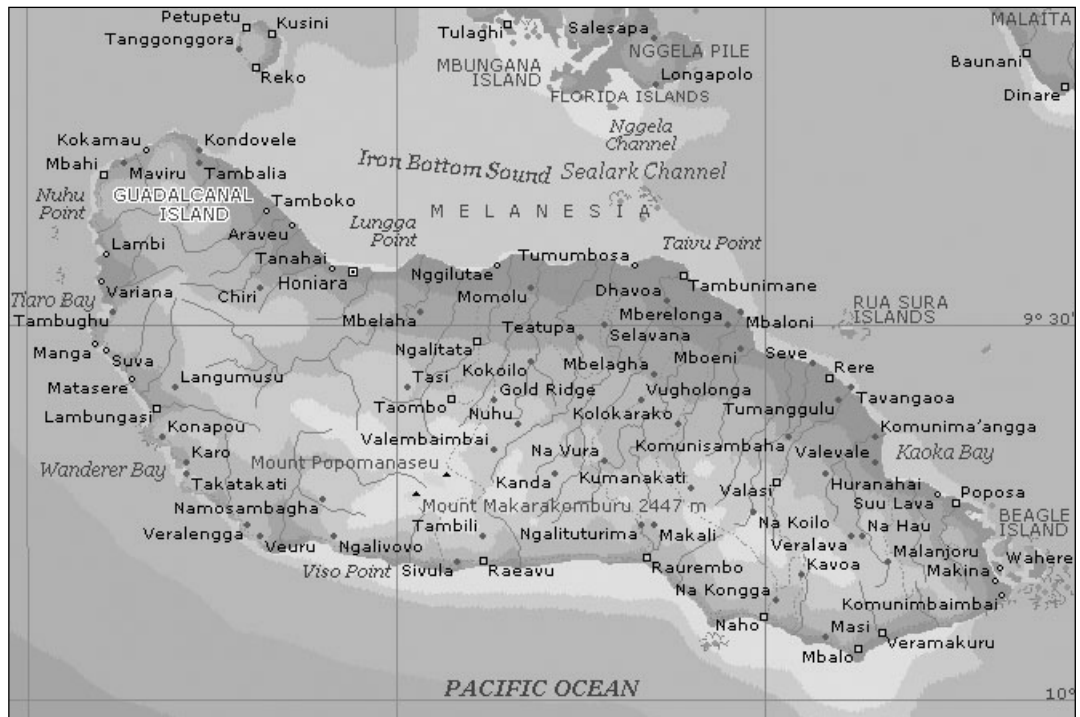



REVIEWS

BOOKS

Reviewed by Ruth Parnell

SURGERY AND ITS ALTERNATIVES by Sandra A. McLanahan, MD and David J. McLanahan, MD

Twin Stream Books, USA, 2003
ISBN 0-7582-0201-6 (814pp hc)
Availability: Kensington Books, website
<http://www.kensingtonbooks.com>

In the medicalised Western world, surgery is often the first resort to solve health problems, when the alternative therapy approach, which has merits in many circumstances, is barely given a second thought. In their comprehensive volume, *Surgery and its Alternatives*, brother-and-sister team Sandra McLanahan, MD (a family physician practising complementary and integrative medicine), and David McLanahan, MD (a surgeon with over 30 years in general surgery and teaching), give good reason for not automatically deciding on "the knife" but, instead, exploring options.

Fundamental to the philosophy behind their book is that we healthcare consumers need to know how to make the right choices for our health. Therefore, we need to consider our vast range of options when treating specific diseases, and these may involve dietary and lifestyle changes in conjunction with alternative therapies such as yoga and meditation. However, if surgery is indeed the preferred option, there's a wealth of advice in these pages on how to make an informed decision, including questioning your doctor/specialist, getting second and third opinions and calculating the risks. There are tips on how to prepare for the pre- to post-operative phases, and how to adjust

to a new post-surgery lifestyle. A great deal of the authors' advice for the preparation and recovery phases does involve alternative approaches such as using comfrey compresses to help heal incisions and adopting deep-relaxation and visualisation techniques.

The McLanahans devote many chapters to specific parts of the body, including breast, lung, heart and stomach as well as reproductive organs, and provide a balance between alternative and conventional approaches for dealing with health problems. Their suggestions make this book a must for health professionals and their patients as well as anyone who wants to exert some form of personal control over complex health issues.

MAYA: The World as Virtual Reality by Richard L. Thompson

Govardhan Hill Publishing, USA, 2003
ISBN 0-9635309-0-9 (292pp tpb)
Availability: Govardhan Hill, website
<http://www.simulatedworlds.com>;
Adventures Unlimited, website
<http://www.adventuresunlimitedpress.com>

No, this is not a book about the Central American civilisation, but about the world of *maya*, illusion—the virtual world. In *Maya*, Richard L. Thompson, mathematician and author of seven books covering diverse subjects such as archaeology, ancient astronomy, cosmology, quantum physics and spirituality, considers virtual reality (VR) as a metaphor for our consciousness and our place in the Universe.

Thompson asks us to view consciousness not as a product of matter—which is the mechanistic world view—but as a separate element beyond the physical. Using the scenario of someone entering a computer-simulated VR world through a sensory interface,

he wonders whether we are actually living in a virtual reality that is part of a vastly larger virtual Universe. He goes on to explore the hypothesis that "the world is an illusory construct of a Ground Reality that includes our consciousness".

His first few chapters cover computers and VR, the laws of physics, quantum mechanics, relativity and time, while his "many worlds" discussion leads into chapters on how consciousness may affect natural phenomena. These describe thought and remote viewing experiments, visions and hallucinations, OBEs and NDEs, as well as anomalous energetic and healing phenomena.

Thompson's hypothesis reaches the same nexus as ancient Hindu and Buddhist traditions, in which consciousness is a paradox: as "the One", it is the source and sustenance of everything; and as "the Many", it is the awareness manifest in individual beings. This mind-expanding journey takes us from *Matrix* territory to *maya* and beyond.

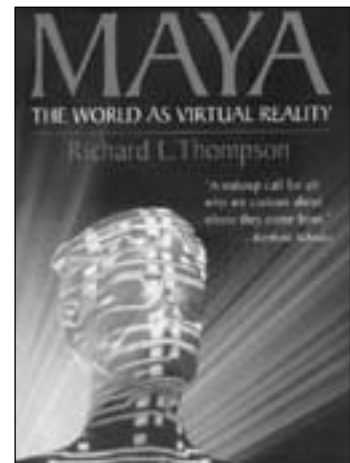

REVIEWS



WHAT REALLY CAUSES AIDS

by **Harold D. Foster**

Trafford Publishing, Canada, 2002

ISBN 1-55369-132-6 (195pp tpb)

Availability: Trafford Publishing, website
<http://www.trafford.com>

Harold D. Foster, PhD, is a tenured professor who has worked out of the Geography Department at the University of Victoria, BC, Canada, since 1967. He has authored or edited some 190 publications, mostly focusing on reducing disaster losses or identifying the causes of chronic disease or longevity, and has published hypotheses on the origins of numerous diseases. Here he turns his attention to HIV and AIDS, and his hypothesis is that AIDS is caused by a number of co-factors. He rejects the mainstream view that HIV in its various forms is the sole cause of AIDS, but he also refutes mavericks such as Dr Duesberg who maintain that HIV does *not* cause AIDS.

One observation Foster has made (no doubt helped by his geography background) is that the AIDS explosion in Africa is occurring in countries and regions with soils deficient in selenium. Senegal, with high levels of selenium in the soil and food chain, has the lowest AIDS rate in Africa. Foster has determined through his research that diets high in selenium offer immunoprotective benefits. Indeed, HIV and AIDS patients have severely depressed immune systems and levels of serum selenium that are low and decline further as the disease progresses. Foster sees the AIDS pandemic as "only one of several ongoing catastrophes involving viruses that encode the selenoenzyme glutathione peroxidase". As these viruses replicate, they steal selenium from their host because their genetic codes have a

gene that is almost identical to the human enzyme. But there's more. As HIV-1, for instance, replicates, it also depletes the host of the other three components of this enzyme: cysteine, glutamine and tryptophan. Thus, Foster regards AIDS as a nutritional deficiency illness caused by a virus—an illness that can be treated or prevented by intake of these three components as well as selenium. Such supplementation already has a good track record in treatment protocols.

Foster's hypothesis resolves many of the anomalies in conventional HIV=AIDS "wisdom". His book is well-referenced and contains a series of tables listing all the foods high in these four nutrients and which also help protect against other diseases such as cancer. An important interpretation.

HEALING SOUNDS: The Power of Harmonics

by **Jonathan Goldman**

Healing Arts Press, USA, 2002 (2ed)

ISBN 0-89281-993-6 (176pp tpb)

Availability: Destiny Books,

<http://www.InnerTraditions.com>;

<http://www.healingsounds.com>; NEXUS

NZ Office, tel (09) 405 1963

Much has happened in the field of sound science and healing since this book was published a decade ago. In the preface to this second edition of *Healing Sounds*, author Jonathan Goldman, who is highly regarded internationally as a master teacher in sound therapies and has produced numerous visionary albums, reflects on how the awareness of sound and music as healing modalities has continued to expand over the years. But so, too, has the science to back it up, and Goldman believes it's imperative to combine scientific *and* spiritual approaches

for true discovery and exploration of the ability of sound to heal and transform.

A landmark text in this field, *Healing Sounds* gives a glimpse into the incredible potential of vocal harmonics and toning as a tool for self-health and transformation and also as a means for groups to effect positive change through chanting and meditation. To help us understand the context of these sound harmonics, Goldman covers the esoteric history of sound and harmonics, with the influence of the Pythagorean mystery school, the Jewish Kabbala and other diverse traditions employing shamanic, tantric or occult practices. The Hoomi singing of Mongolia and Tuva and the harmonic vocalisations of the Gyuto and Gyume monks of Tibet are examples of ancient traditions whose sacred chanting styles have influenced modern Western approaches to sacred harmonics.

If you haven't read this book and are interested in sound healing, then look no further.

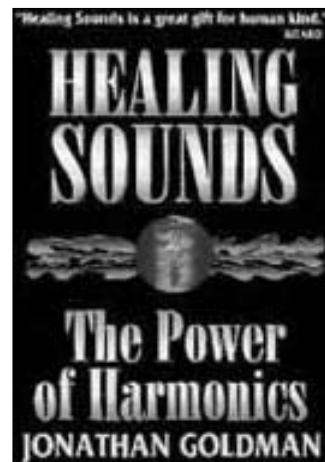



REVIEWS

FIRESTORM: Dr James E. McDonald's Fight for UFO Science by Ann Druffel

Granite Publishing, USA, 2003
ISBN 0-926524-58-5 (640pp tpb)
Availability: Wild Flower Press/Granite Publishing, <http://www.5thworld.com>

Dr James McDonald was a brilliant US atmospheric scientist and a dedicated humanist who devoted much of his natural curiosity to the UFO phenomenon from the late 1950s until his tragic death, supposedly by suicide, in 1971. *Firestorm* is a biography of his life and work, with the focus mainly on his research into UFOs and his attempts to have the subject taken seriously by fellow scientists and the government. It's written by veteran UFO investigator Ann Druffel, who became acquainted with Dr McDonald during her time with NICAP, the National Investigations Committee on Aerial Phenomena. French UFO researcher Dr Jacques Vallée, who knew McDonald, has written a fitting foreword.

Druffel had access to Dr McDonald's private archives, including a little-known four-volume diary, as well as to family, friends, associates and detractors. She has produced a fascinating account of this driven man within the context of his times and some ufological milestones of the 1950s–60s. Dr McDonald only went public on UFO issues in 1966, after eight years of private study during which time he was subject to CIA and other agency surveillance. Yet he was less convinced of a top-level government/military/intelligence conspiracy, preferring to think there were only minor, isolated cover-ups and lots of foul-ups.

He sparred for years with military insiders like J. Allen Hynek of the USAF (who went

on to establish a UFO research centre), arch sceptic and *Aviation Week* writer Philip J. Klass, and many scientists and academics. (He also had an interesting visit to Australia and New Zealand in 1967.) Following years of official debunking, the 1969 release of the Condon Report—which concluded that nothing of value would come from UFO research—was a thorn in Dr McDonald's side and no doubt contributed to his subsequent depression and demise.

There's plenty of intrigue, deception and truth-seeking in Druffel's well-documented, perceptive account of a man prepared to go out on a limb for his scientific curiosity. An important addition to ufological literature.

THE MASTERS OF THE MYSTICAL ROSE: A History of the Grail Family by Maree Moore

Triad Publishers, Australia, 1999
ISBN 0-958670-75-7 (731pp tpb)
Availability: Joshua Books, Australia, tel +61 7 5444 1971, website <http://www.joshuabooks.com>

The Western occult tradition is full of references to the influences of ancient masters, particularly the so-called Great White Brotherhood. It was Madame Blavatsky who, from the 1880s, first drew attention to these "ascended masters" in her theosophical works. According to this treatise by Western Australian author Maree Moore, the masters have a long pedigree indeed.

Cropping up with regularity through occult history are St Germain, whose many key incarnations commence in the author's chronology with Noah; the master El Morya, who gets the guernsey as Abraham; and Kuthumi, who is credited as having been the Pharaoh Tutmoses III, great-grandfather of

Akhnaton (also El Morya). The master St Germain is regarded in some "mystical rose" circles as having been the incarnation of Roger Bacon, Christopher Columbus and Sir Francis Bacon; El Morya of Thomas Becket and Sir Thomas More; Kuthumi of Lao Tzu, da Vinci, magician Sir John Dee and botanist Sir Joseph Banks (there's an interesting chapter on the discovery of Australia here). All hard to believe?

Well, steep yourself in *The Masters of the Mystical Rose* and you may begin to think otherwise. The author is a member of the Francis Bacon Research Trust, which is dedicated to preserving Baconian-Rosicrucian philosophies and ancient wisdom teachings, especially those enshrined within the Shakespearian plays (reputedly the legacy of Francis Bacon, alias St Germain) and the Grail Family traditions. These vast esoteric perspectives, involving greater and lesser masters who have made their mark on our world, reveal new insights to make sense of the scattered jigsaw puzzle of history.

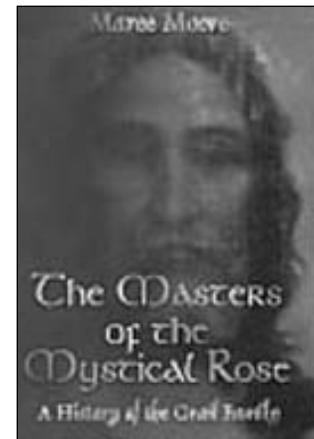

REVIEWS



THE H.I.S.S. OF THE A.S.P.: Understanding the Anomalously Sensitive Person

by David Ritchey

Headline Books, Inc., USA, 2003

ISBN 0-929915291 (390pp tpb)

Availability: Websites <http://www.headlinebooks.com>, <http://hissofasp.com>

Independent psychological researcher David Ritchey has noted from 10 years of scientific investigation and 15 years' experience as a clinical hypnotherapist that a significant minority of people can be described as "anomalously sensitive persons" (ASPs). A high proportion of these people are women, and most of them are sensitive on several levels and are often highly gifted and creative individuals.

According to Ritchey's studies, outlined in *The H.I.S.S. of the A.S.P.*, it's not uncommon for someone to be sensitive to physical stimuli, be electrosensitive and have immune system disorders, as well as have tendencies towards extrasensory perception (ESP) and communication with spirit worlds.

The areas of sensitivity Ritchey delineates touch on physiological, cognitive, emotional and transpersonal states. He sees the "ASPness" trait as a function of the structure and chemistry of the brain, and that it has significant psychological, medical, educational and social implications. Many of these sensitivities Ritchey believes can be measured, and he has developed a detailed questionnaire—what he calls the "H.I.S.S.", the "Holistic Inventory of Stimulus Sensitivities"—which shows that anomalous sensitivity to stimuli in one realm is very likely accompanied by anomalous sensitivity to stimuli in all other realms. Ritchey suggests a model that draws on knowledge from

neuroscience, quantum physics and holography, and which helps bridge the gap between scientific and spiritual worldviews. This challenging book should appeal to the shaman within every psychologist.

SECRET SOCIETIES OF AMERICA'S ELITE: From the Knights Templar to Skull and Bones

by Steven Sora

Destiny Books, USA, 2003

ISBN 0-89281-959-6 (324pp tpb)

Availability: Destiny Books, website <http://www.InnerTraditions.com>; Adventures Unlimited, <http://www.adventuresunlimitedpress.com>; NEXUS NZ Office, tel (09) 405 1963

The banning and break-up of the Knights Templars in 1307 changed the course of the history of Western civilisation, forcing the order to regroup underground. This was directly responsible for the dramatic rise in piracy, as many of its members took to the sea to escape a "predestined life" back home. Others fled to Scotland and many to the Swiss Alps, where they created a neutral stronghold with its own guard and eventually its secretive banking services. They resurfaced in North America, even before the time of Columbus, and their legacy was perpetuated by the Masons, "remnant Templars", writes Steven Sora in *Secret Societies of America's Elite*.

In fact, individuals with links to Masonry have had an enormous influence on the progress of America since its inception as a colony with essential ties to lands beyond the ocean. Sora (author of *The Lost Treasure of the Knights Templar*, reviewed in 6/04) paints a picture of the rise of elite

families and their links to their British or European homelands. Their fortunes were often founded on the spoils of smuggling, piracy and privateering, and they were protected up to the highest level by fellow Masons who in turn made profits from their entrepreneurship. Later, they would profit from the opium trade with India and China.

Fraternity—particularly the secret variety—was more important than liberty or equality, and this mindset also allowed the slave trade to flourish. It led to the creation of secret groups such as the Ku Klux Klan and the Yale Order of Skull and Bones, which hand-picks 15 new "Who's Who" recruits each year and whose "chaotic" influence from elite levels has resounded through the generations. Both George W. Bush and his father are members.

Sora profiles only a few of the famous American names and can only cover so much of their antics today, but his investigation makes for a ripping yarn that gives a context to modern-day piracy.

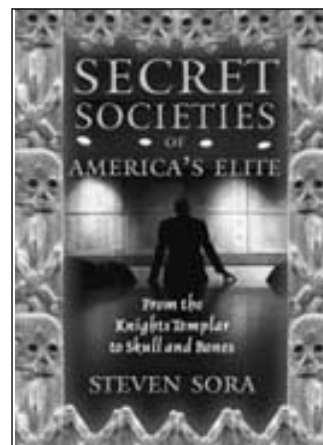



REVIEWS

AMERICA'S SECRET ESTABLISHMENT: An Introduction to the Order of Skull & Bones

by Antony C. Sutton

Trine Day, USA, updated reprint 2002

ISBN 0-9720207-0-5 (317pp hc)

Availability: Trine Day, <http://www.trine-day.com>; Adventures Unlimited, website

<http://www.adventuresunlimitedpress.com>

More detail on the Yale University Order of the Skull and Bones and its role in two centuries of US history can be read in Antony Sutton's classic book, *America's Secret Establishment*—first published in the early 1980s as a four-part series and a few years later as an enlarged volume. This 2002 edition is an updated reprint with a new foreword by Sutton—written, as it turned out, not long before his death.

The Hegelian philosophy of "divide and conquer" is as alive today among "Bonesmen" as it was over 170 years ago when the secret society was formed. One of its expressions, Sutton laments, is in the "dumbing down of America" via the education system—a 19th-century Prussian import at odds with classical liberalism and which fosters the state above the individual.

The society has produced titans of industry, judges, defence ministers, media magnates, intelligence agency heads and three Presidents—two of them Bushes. In fact, Bonesmen from the Bush and Prescott families became a major force in drug smuggling and supplying from the 1860s. Their descendants' "War on Drugs" laws smack of hypocrisy—as Sutton points out has become evident since his first edition came out.

Central to the Bonesmen's philosophy is that progress is achieved through the clash of opposites, through "contrived conflict".

Thus, the ends justify the means, and if that also means preventing the masses from having access to non-polluting, "free energy" sources while protecting the oil industry, or insisting they eat unproven genetically engineered food while supporting the "life sciences" industry, then so be it. To counteract the powerful negative forces of the Bonesmen and their cronies, Sutton says we need to overcome their entrenched, inequitable systems and implement creative education solutions with a lot less propaganda attached. By way of background, he includes rare Skull and Bones-related documents plus lists of members (1833 to 1985) and their links in business and politics.

On a parting note, Sutton prophesies that time will erode the power of this secretive group, as "Nothing this outrageous can survive forever". Let's hope he's right.

PYRAMID OF SECRETS

by Alan Alford

Eridu Books, UK, 2003

ISBN 0-9527994-2-1 (440pp tpb)

Availability: Eridu books, website

<http://www.eridu.co.uk>

In his fifth book, Alan Alford rejects the idea that the Great Pyramid of Giza was "a tomb and nothing but a tomb". Instead, he speculates that the Pyramid was a symbol of the creation of the Universe, and that the Pharaoh Khufu may still lie buried beneath it, probably within the subterranean Grotto. Such a placement would be consistent with the Egyptian cosmological axiom, "the Body to Earth, the Spirit to Sky".

In *Pyramid of Secrets*, Alford doesn't investigate who built the Great Pyramid or how it was built, but *why* it was built the way it was, particularly with its phenomenal

size, its exceptional precision and its array of secret passages. Certainly other authors have alluded to the King's Chamber as having cosmic acoustic properties, but Alford believes there was no Pharaoh's body entombed in the granite sarcophagus; rather, a chunk of iron meteorite was in place. This ancient Egyptian religion was a cult of creation, and the meteorite represented a connection between the seed of the Pharaoh and the spirit world, the cosmic source. The acoustics of the King's Chamber would resonate down to the Pharaoh's burial site—which was on the highest substratum of the Giza Plateau—and back out to the cosmos.

Based on his analysis, Alford concludes there are yet more secrets awaiting discovery in subterranean realms as well as within the Pyramid proper. The plugged shafts of the Queens Chamber may well be time capsules containing age-old information about our creation and history. Time will be the judge of how accurate he is.

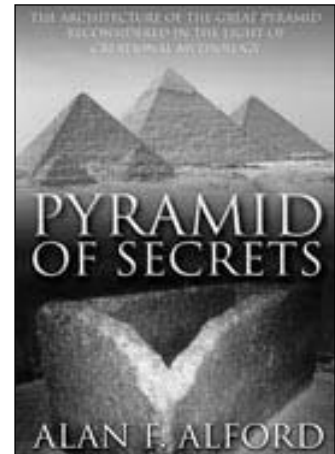

REVIEWS



THE AGE OF CONSENT: A Manifesto for a New World Order

by **George Monbiot**

Flamingo/HarperCollins, UK, 2003

ISBN 0-00-717124-2 (274pp tpb)

Availability: Flamingo, website

<http://www.fireandwater.com>

I admit I was a little taken aback by the title of George Monbiot's courageous new book, and confused by the subtitle when *the New World Order* manifesto is already progressing apace in the hands of the Bush cabal. But what Monbiot—the UK academic, *Guardian* columnist, author (*Captive State*, see 8/03) and key figure of the "global justice movement"—has in mind by *his* New World Order is a global democracy in which each person has one vote.

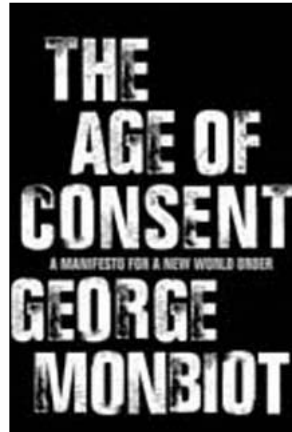

Monbiot's new utopian vision encompasses an Age of Consent of/by/for the people to counteract the Age of Coercion in which we find ourselves now. His remedy for accommodating the will of the people includes changing or removing inequitable and environmentally destructive institutions like the IMF and World Bank, introducing a Keynesian "credit clearing" system, implementing a global Fair Trade system, and reforming the UN General Assembly and Security Council so that nation-states give way to true globalisation—not internationalism. The people, individuals all around the planet, need to have their say on a global level—after all, corporations are certainly having theirs, and many issues affecting us, such as climate change, are global in scope.

This sounds all well and good, but asking the rich and mighty to cede some of their wealth and power to the masses seems overly optimistic. It's hard to believe that, at the extreme, a secret cabal which funds black projects with black money could even contemplate giving up any power for some democratic world parliament. These forces have to be factored in; and while Monbiot has fingered many of the baddies, there are even worse baddies behind them! Monbiot

asks us not to reject his proposals unless we have something better to offer—although some of his critics in the movement think they do. He asserts that the answers lie with us, the people of the world.

EARTH RISING II: The Betrayal of Science, Society and the Soul

by **Dr Nick Begich & James Roderick**

Earthpulse Press, USA, 2003

ISBN 0-9527994-2-1 (222pp tpb)

Availability: Earthpulse Press, Inc., website

<http://www.earthpulse.com>;

Adventures Unlimited, website

<http://www.adventuresunlimitedpress.com>

In 1991, Alaskan environmental activist James Roderick was the first to twig to the threat from the HAARP facility then being built near Gakona, and fellow activist Dr Nick Begich joined his NO HAARP cause within two years of that. They've collaborated on various projects and Earthpulse Press books since then (including *Earth Rising I*; see 7/03), and were about to complete four years of research and writing for *Earth Rising II* when Roderick died in August 2002. So Begich finished the project and has included touching tributes to Roderick as well as his father, Nick Begich, Sr, the Democrat Congressman for Alaska who went missing, never to be seen again, when his light plane disappeared over southeastern Alaska in 1972. In the subsequent 30 years, Begich has dedicated himself to the path of truth, to making a positive difference in the world—as his collaborator and close friend James Roderick did, too.

For this volume, the authors focus on new technologies with often unseen but life-threatening if not deadly consequences. First up is the new generation of high-intensity, low-frequency underwater sonars being deployed by the US Navy—already with detrimental effects on marine life and the underwater environment. Next is cellphone EM/RF exposure and the evidence suggesting there are indeed hazards for human health which require further research, regulation and a precautionary approach.

The following chapters look at the problems of the surveillance society, with new technology being employed to track citizens, immobilise them with "non-lethal" microwave weapons and control them with such "advances" as implantable microchips. The authors have done their homework, and the technological developments they discuss are well referenced. These weapons of mass control have truly frightening implications, yet they are not subject to international conventions. The authors urge us to get active against this insidious betrayal of science, society and the soul that threatens our true freedom and potential as human beings.



REVIEWS

THE LIFE CYCLE OF CIVILIZATIONS

by **Stephen Blaha**

Pingree-Hill Publishing, USA, 2003
ISBN 0-9720795-8-0 (270pp tpb)
Availability: Pingree-Hill Publishing, PO
Box 368, Auburn, NH 03032, USA, tel
(603) 626 1566; Barnes & Noble,
<http://www.b&n.com>

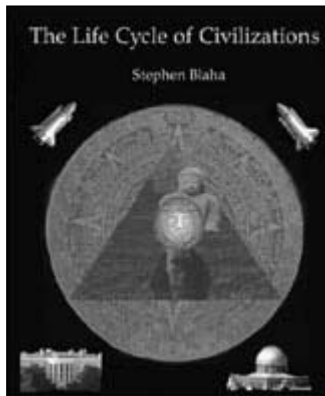

Following on where historian Arnold Toynbee left off with his theory of civilisations, US physicist, computer scientist and historian Dr Stephen Blaha has devised a mathematical model that attempts to explain the rise and fall of civilisations. While Toynbee believed mankind has survived through at least 26 civilisations since "pre-historic" times, Blaha suggests at least 41 by his model, which also factors in changes due to climate change and "barbarian" invasion. His *Life Cycle of Civilizations* is a new edition of his 2002 *The Rhythms of History*.

The timeline extends back 40,000 years when a genetic mutation occurred, as confirmed in new findings (Ding et al., 2002). This allowed for the Upper Palaeolithic explosion in human culture where a "creative minority" was able to emerge and provide leadership for the development of civilisation—though it was only after the Ice Age ended 10,000 years ago that the first true civilisations were possible due to more favourable environmental conditions.

Dr Blaha has developed equations which when calculated can be converted to graphic form to show peaks and troughs of civilisations following a four-generational, "three and a half beat" cyclic pattern, not unlike the "damped harmonic oscillator" of physics which describes the cyclic motion of pendulums and bells. It's uncanny how the model fits the historical records. Common to all civilisations is the start-up phase, which typically lasts 133.5 years before the first breakdown commences due to the interplay of internal human social dynamics, after which there are several routs and rallies over the next 800 years and then disintegration.

Dr Blaha believes that his equation and

charts can be used to make predictions about the future of civilisations—and can even plot the influence of an advanced ET culture. He sees Japan's breakdown cycle beginning around now, the West declining towards a low point around 2050, and the Muslim nations, China and India on a roll till roughly 2084. A rather sobering theory!

INTO THE BUZZSAW

edited by **Kristina Borjesson**

Prometheus Books, USA, 2002
ISBN 1-57392-972-7 (392pp hc)
Availability: Prometheus Books, website
<http://www.prometheusbooks.com>

Had investigative reporter Kristina Borjesson not been assigned to investigate the crash of TWA Flight 800 in July 1996 and later been fired by the CBS network, this book may never have been written. But she was not alone in experiencing "the buzzsaw"—concerted corporate or government efforts to kill controversial stories and put their investigators out of the picture.

For this compilation of essays, introduced by Gore Vidal, Borjesson has collaborated with 17 award-winning print/radio/TV journalists and producers who all have their own take on the parlous state of today's investigative journalism and corporate media culture where self-censorship has become rife. In explaining how the Fourth Estate has become a lapdog rather than a watchdog, these journalists weave in their personal stories with details of the crime, corruption and conspiracy they're trying to expose. There's Gerard Colby on how his book on the DuPont family was "privished" so it would sink without trace; reporter Jane Akre's run-in with Fox TV over her exposé on Monsanto and its GE bovine growth hormone; and trans-Atlantic print/TV journalist Greg Palast's dealings with the American media and their cover-up of Presidential vote-fixing in Florida. NY-based columnist Philip Weiss laments the cultural change in journalism in the 1990s that ensured that the bigger stories behind Bill Clinton's time as Arkansas Governor or the FBI's suppression of evidence from Ruby Ridge, Waco and OKC never made it to the mainstream press.

There are contributions from former AP news journalist J. Robert Port, whose team was the first to write about US massacres of South Korean civilians in the early days of the Korean War; ex-DEA agent Michael Levine, on the mainstream media as the drug war's "shills" designed to distract our attention; and former *San Jose Mercury* reporter Gary Webb's exposé on the CIA supplying crack to black LA neighbourhoods to fund a Central American regime. These revelations make this a disturbing read, but the book is so rivetting it's hard to put down.

REVIEWS



DVD

Reviewed by Duncan Roads

CROP CIRCLES: The Ultimate Undercover Investigation

© J.H. Gibsone, UK, 2003

Distributor: CropCircleConnector, website, <http://www.cropcircleconnector.com>

This is definitely one of the most informative and entertaining films made to date on this most intriguing subject. The film adopts the theme of an undercover investigation, though the viewer doesn't have a clue who is undercover or what the cover they are under is all about. That bit aside, the result is a wonderful documentary that leaves you feeling as though you are there.

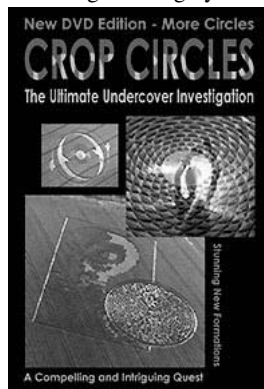

There is absolutely fabulous use of aerial filming and photography of crop circles, including many from 2001 and 2002. And yes, that ET/disc formation is here, too.

I particularly liked the spontaneous interviews with the many people visiting the circles from around the globe. As well as these, there are interviews with the locals—farmers, horseriders, pilots, etc.—and some of their stories are especially intriguing.

The views and theories of all the locals combined with those of the researchers, the true believers and the sceptics make for a pretty comprehensive picture of how the phenomenon is affecting people—which would appear to be positively.

I found the film gave time for the viewer to relax and absorb the sounds and feel of the landscape as well as the formations themselves. By the time the "undercover agent" reached the famous Barge Inn, I was so "in there" that I swear I could smell the beer as the camera entered the place. Totally recommended!

If you don't have a DVD player, this is also available on video (NTSC or PAL)

VIDEOS

Reviewed by Duncan Roads

PERU'S MYSTERY IN STONE

Produced by Terra Entertainment, USA, (30mins, NTSC)

Distributors: Terra Entertainment, website <http://www.shopterra.com>; Adventures Unlimited, website <http://www.adventuresunlimitedpress.com>

High atop a remote plateau in northern Peru, hundreds of elusive shapes can be seen in the living rock. Are they the result of natural erosion, or were they carved by the hand of man?

The plateau seems to be covered with figures carved in the rock, which is dioritic porphyry (a volcanic rock almost as hard as obsidian). But these figures are not fashioned like the statues we are used to seeing in our museums. Rather, they can only be seen from one point of view.

If you were to move five feet left or right, the image might no longer be recognisable. The film crew noticed that when they found an ideal viewing spot, there were often steps leading up to it and a little seat carved into the rock right where they were standing!

A short but interesting documentary.

HOLISTIC THERAPIES – DEMONSTRATIONS

Produced by E&E Productions, Australia, 2003 (35mins, PAL)

Available: **Australia**—The Darwin Holistic Health Centre, GPO Box 824, Darwin NT 0801, tel (08) 8941 1699; and E&E Productions, PO Box 444, Oaklands Park SA 5046, <http://www.eande.va.com.au>

This is a gentle half-hour introduction to many of the complementary therapies used in Australia today. As well as demonstrating them in action, the video explains via the practitioners involved the principles of how some of these complementary, or holistic, therapies work. These include the Feldenkrais Method, Reiki, Iridology, Pranic Healing, Meditational Belly Dance, Orthobionomy, Chi Kung, Acupressure Massage, Hypnotherapy, Neuro Linguistic Programming (NLP), EMF Balancing, and a type of Vibrational Kinesiology.

Judging by the lush tropical background, I would say that the video was filmed in Darwin. I certainly felt warm and comfortable while watching it. Overall, this is a good introduction to some of the lesser known holistic therapies.

Now Available!

MultiWave Oscillator

Astute **NEXUS** readers will already know of Lakhovsky's MultiWave Oscillator (MWO) and what it can do for you.

Here is your chance to own one.

The first available Australian model, complete with copper-tube antennae, and built with the assistance of former Borderland Science Foundation (USA) researchers.

Please contact us through our website at -

<http://www.i4cau.com>



REVIEWS

MUSIC

Reviewed by Richard Giles

COVER THE WORLD

by various artists

Putumayo, USA, 2003 (54mins)
Distributors: **Aust**—MRA, tel (07) 3849 6020; **UK**—Pinnacle Imports, tel 01689 870622; **USA**—Putumayo, tel 1888 7888 8629, <http://www.putumayo.com>

I confess to a weakness for '60s and '70s hits, and this release is a great tribute to artists as diverse as Lou Reed, Ray Charles, Jackie Wilson, The Four Seasons, Jimi Hendrix and Bob Marley, whose songs are covered here in these new interpretations. To hear a group from Senegal, South Africa, Benin, Ivory Coast or Japan cover a famous hit in its own style is exciting. Among the performers are Angelique Kidjo, Touré Kunda, Les Go and Fatal Mambo.

FIELDS OF GREEN

by Paul Benhaim Hemp Plastic Music

Paul Benhaim – Hemp Music Productions, Australia, 2003 (53mins)
Distributors: **Aust**—Hemp Music, tel (02) 6684 0066, website <http://www.hempmusic.com>; **UK**—Changing World Dist., tel 04158 250317; **Germany**—HemPro Intl, tel 0211 323 7922

You heard it first at NEXUS: news of the world's first hemp plastic CD project—the case, paper and didgeridoo all made from hemp! Its time has come. Paul Benhaim is one of the people in this project with eight other groups promoting hemp fibre. The CD is an Australian first and the music is a marvellous blend of harp, flute, didge, acoustic guitar and beautiful voices, produced by Paul and Tarshito (NEXUS 7/04) on Queensland's Gold Coast. Ten per cent of profits goes to charity, so this is an album worth supporting. The music is gold, too, with some superb relaxation sounds.

BUENOS HERMANOS

by Ibrahim Ferrer

World Circuit Ltd, UK, 2003 (55mins)
Distributors: **Aust**—MRA Entertainment, tel (07) 3849 6020; **UK**—World Circuit, tel (0)1689 870 622, website <http://www.worldcircuit.co.uk>

I'm sure most have seen this happy, humble and adorable man in *Buena Vista Social Club* as the front vocalist with Ry Cooder (NEXUS 5/02). The world revival of Cuban music has seen all those from *Buena Vista* move out into the international scene after decades of obscurity. Thanks, Ry! Here, Ferrer performs classic Cuban tunes mixed with some new pieces with that beautiful

Cuban chorus work and trumpets, sax, drums and piano. Ferrer is joined by Ry Cooder (guitar), Joachim Cooder and Jim Keltner (drums), Chucho Valdés (piano), Manuel Galbán (organ) and others. Wonderful, cool, Cuban dance party music.

EL SULTAAN:

CLASSICAL EGYPTIAN DANCE

by Hossam Ramzy

ARC Music Prodn, UK, 2003 (47mins)
Distributors: **UK**—ARC, tel +44 (0)1342 328567, <http://www.arcmusic.co.uk>

Belly-dancing music is great for loosening up to, and is part of the Egyptian musical tradition. Hossam Ramzy is one of the Middle East's great percussionists, having played with many of the big names in modern music (including Robert Plant and Jimmy Page for *No Quarter* in 1994). Through ARC Music he has released a number of albums dedicated to the Egyptian dance tradition, with old and new songs. This is very moving and exciting music.

OVER NINE WAVES

by Rebecca Hood

Rebecca Hood Music, 2002 (54mins)
Distributor: **Australia**—Rebecca Hood Music, tel +61 (0)7 5445 7478, websites <http://www.indie-cds.com>, <http://www.clarsach.net/>

It's rewarding to see local performers produce and promote their own CDs. Rebecca Hood lives in the hinterland of the Sunshine Coast in Queensland, Australia. She studied the metal-strung harp under Canadian Ann Heymann, a leading exponent of this premier instrument of the Gaelic peoples of Ireland and Scotland. It requires a fingernail plucking technique to produce its unique bell-like tone in the playing. After almost disappearing in the 17th century, it was revived in the 20th. Rebecca's album is world class, admirably promoting the glorious sound of this ancient instrument.

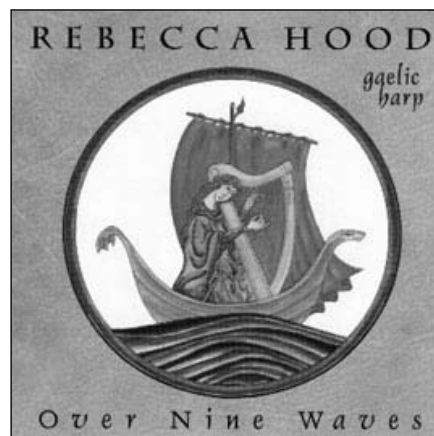

Continued from page 47

The one wire screen method, as described earlier in this article, is the method currently in use for the machines Lee is providing and in the MexiStim machine I build by request. Though you can cut a piece of wire mesh screen to whatever size you want, I use a 1 x 1-foot wire screen for local application and a 3 x 3-foot wire screen under my mattress pad for all-night application.

All you do is attach one corner of the wire screen to the negative pole of the batteries and leave it for 15 minutes, then attach it to the positive pole and leave it for 15 minutes, then repeat; or you can build a switching timer so it does it by itself; or buy one of the prebuilt and tested machines and save all the hassle.

Lee Crock and Tom Berryhill recently reported that you can connect the output wire to a metal bathtub filled with water or just suspend it in the water, then sit for a while to experience what Lee calls the "Fountain of Youth".

In the 1900s, people used "galvanic baths" for medical treatments, but this machine doesn't have a current path so it

shouldn't be doing anything. Since the machine is battery powered, I think it is perfectly safe due to there being such a low voltage and no current flow. The MexiStim unit I build has a completely separate battery system isolated from the AC adaptor-powered timer. I definitely plan to try this "Fountain of Youth" claim.

Once again, if you want to read more about the Energy Cleaner machine, its history, testimonials, instructions for using it, etc., go to Lee Crock's website at <http://www.edkuniversity.com> or read the KeelyNet article at <http://www.keelynet.com/biology/crock.htm>.

Should you wish to contact Lee Crock, enquire about purchasing one of his Energy Cleaner machines or make an appointment to visit his university to try out a machine (think of it as a mini-vacation), his contact details are:

EDK University, PO Box 313
Williamstown, WV 26187, USA
Telephone: +1 (818) 375 5081,
Email: lcrock@edkuniversity.com or
Energycleaner@aol.com

THE MEXISTIM UNIT

For those who might not have the techni-

cal ability or patience to build one of these machines, I can build you a MexiStim unit for US\$200 plus shipping (without the 10 'D' cell batteries, as they are too heavy to ship)—approximately US\$50 to ship from Mexico to the United States, and more for overseas. Be aware that shipping from Mexico takes at least three weeks due to Mexican mail service.

Since I have been here in Mexico, I've met a North American lady named Donna who wrote a best-selling book on anger management and was invited to appear as a guest on *Oprah*. Donna told me that her son, who is in his early 30s, had an incurable sarcoiditis cancer.

He was visiting here for a week, so she took him around for aromatherapy, acupuncture and anything that might help him—none of which did.

I told her about the Crock machine and lent him the unit I brought to Mexico. He said he could feel a heat coming from the pad, so he used it during the last three days he was here.

On his return home, he had an MRI done and the doctors told him his cancer appeared to be "melting", so he was eager to spend more time using the machine but

Lee Crock's 'Aura Therapy'/'Energy Cleaner' Machine

could not afford Lee's US\$3,000 "lease with option to buy" terms.

So impressed was he and his mother with the results of even a short exposure to the machine that his mother asked me to build him a MexiStim unit—which I did, and I mailed it to him in Connecticut. This was in 2002.

Donna only stays here with her husband for about six months of the year, so they went back to the States and I forgot about the machine. About two months ago, around March 2003, she returned and was all effusive, saying the machine I sent her son had healed his sarcoiditis cancer, as proved by MRI and biopsy. They were both ecstatic, though the doctors claimed the cure was a case of "spontaneous remission".

A lady friend in Dallas had rectal cancer and I lent her one of the other Crock machines which Lee had lent us to let people use. She now reports she is cancer free and is now taking the machine to another friend who has many ailments, so we are hoping it will help him.

I recently received an email from a medical practitioner in England who is using one of my MexiStim units, and he wrote:

"Have my cancer patient on box and already getting positive feedback from her. Within an hour of using it, her pain in the chest had reduced by 75%. The next morning her energy was also good, so we'll see how she does as she has to have chemo next week again. She only has a 10% chance of survival, so this should prove interesting."

I have built several MexiStim machines at the request of people who visit KeelyNet. My version uses the original 3 vdc system with an AC adaptor to power the custom-switching timer circuit I build, and is powered by 10 batteries.

Also included with the MexiStim device is the custom-switching timer circuit board, a jack for the AC adaptor power, the AC adaptor as shown, a jack for the wire screen connection and the cable connected to the approximate one-foot-square wire mesh screen, all of which comes with the unit for US\$200 plus shipping and is tested before shipping to ensure correct operation.

If you'd like to order a MexiStim unit or have questions or comments, feel free to email me at jdecker@keelynet.com or through <http://www.keelynet.com>, or you can write to:

Jerry Decker
APDO Post 17 CP
Chapala, Jalisco
Mexico 45900

I can take payments via credit card (please provide cardholder name, billing address for your card, card number, expiration date and shipping address), or through PayPal (<http://www.paypal.com>), sent to my email address.

My goal, here in central Mexico, is to build an alternative science research centre. KeelyNet has many dozens of projects which have commercial potential and need one or more investors or partners to finance them. The returns could be phenomenal and we could do much to quantify so many of the bogus claims in the alternative science arena. That includes many projects relating to free energy, gravity control, health machines and rejuvenation systems. KeelyNet interests and technical information are both wide-ranging and prolific in many areas.

If you are interested in investing in or discussing this alternative research centre, please email me at jdecker@keelynet.com.

∞

From Helix to Hologram: An Ode on the Human Genome

Continued from page 53

References

- Berezin, A.A., Gariaev, P.P. et al. (1996), "Is it possible to create laser based on information biomacromolecules?", *Laser Physics*, vol. 6, no. 6, pp. 1211-1213.
- Bohm, David (1980), *Wholeness and the Implicate Order*, Routledge, London.
- Copley, Jon (2003), "Proof of Life", *New Scientist*, vol. 177, no. 2383, 22 February 2003, pp. 28-31.
- Gariaev, P.P. (1993), *Wave-based Genome*, VINITI (Institute of Scientific and Technical Information), 15:12, 1993, N. 3092 (278 pages, in Russian).
- Gariaev, P.P. (1994), *Wave Genome*, Public Profit, Moscow (279 pages, in Russian).
- Gariaev, P., Tertishny, G. and Leonova, K. (2001), "The Wave: Probabilistic and Linguistic Representation of Cancer and HIV", *Journal of Non-Locality and Remote Mental Interactions (JNL RMI)*, vol. I, no. 2, May 2002, at <http://www.emergentmind.org>.
- Gariaev, Peter, Boris Birshtein, Alexander Iarochenko et al. (2002), "The DNA-wave Biocomputer", MS, Institute for the Control of Sciences, Russian Academy of Sciences, Moscow, Russia, and Wave Genetics, Inc., Toronto, Canada; also see <http://www.emergentmind.org>.
- Jacobson, Joseph et al. (2002), "Remote electronic control of DNA hybridisation through inductive coupling to an attached metal nanocrystal antenna", *Nature* 415:15-155.
- Hoyle, F. (1981), *The Relation of Biology to Astronomy*, University College Cardiff Press.
- Hoyle, F. and Wickramasinghe, N.C. (1981), in *Comets and the Origin of Life* (ed. C. Ponnampereuma), D. Reidel Publishing Co., pp. 227-239.
- Hoyle, F. and Wickramasinghe, N.C. (1985), *Living Comets*, University College Cardiff Press.
- Hoyle, F. and Wickramasinghe, N.C. (2000), *Astronomical Origins of Life: Steps towards Panspermia*, Kluwer Academic Press.
- Kelleher, Colm A. (1999), "Retrotransposons as Engines of Human Bodily Transformation", *Journal of Scientific Exploration*, vol. 13, no. 1, Spring 1999, pp. 9-24.
- King, Chris (1999), "Fractal Neurodynamics and Quantum Chaos: Resolving the Mind-Brain Paradox Though Novel Biophysics", *Fractals of Brain; Fractals of Mind: Advances in Consciousness Research* 7, at <http://www.dhushara.com/book/paps/consc/brcons1.htm#anchor217145>.
- King, Chris (2003), "Biocosmology", at <http://www.dhushara.com/book/biocos/biocos.pdf>.
- Lawton, Graham (2003), "Live Wire", *New Scientist*, vol. 117, no. 2386, 15 March 2003, pp. 38-39.
- Marcer, P. and Schempp, W. (1996), "A Mathematically Specified Template for DNA and the Genetic Code, in Terms of the Physically Realizable Processes of Quantum Holography", *Proceedings of the Greenwich Symposium on Living Computers* (editors A. Fedorec and P. Marcer), pp. 45-62.
- Marcer, P. and Schempp, W. (1997a), "The Model of the Prokaryote Cell as an Anticipatory System Working by Quantum Holography", *Proceedings of CASYS '97*, 11-15 August 1997, HEC, Liège, Belgium, *International Journal of Computing Anticipatory Systems*, vol. 2, pp. 307-315.
- Maslov, M.U. and Gariaev, P.P. (1994), "Fractal Presentation of Natural Language Texts and Genetic Code", 2nd Intl Conference on Quantitative Linguistics, 20-24 September 1994, Moscow State University, Philological Faculty, pp. 193-194.
- McFadden, Johnjoe (2002), "Synchronous Firing and its Influence on the Brain's Electromagnetic Field: Evidence for an Electromagnetic Field Theory of Consciousness" (CEMI theory), *Journal of Consciousness Studies*, vol. 9, pp. 23-50.
- Miller, I. (1993), "The Holographic Paradigm and the Consciousness Restructuring Process", *Chaosophy 1993*, O.A.K., Grants Pass, Oregon, at http://www.geocities.com/iona_m/Chaosophy/chaosophy11.html.
- Miller, R.A. and Webb, B. (1973), "Embryonic Holography", *Psychoenergetic Systems* (Stanley Krippner, editor), presented at the Omniversal Symposium, California State College at Sonoma, Saturday, September 29, 1973; reprinted in *Psychedelic Monographs and Essays* (1993), vol. 6, pp. 137-156; also in *JNL RMI*, vol. I, no. 3, October 2002, at <http://www.emergentmind.org>.
- Miller, R.A. (1974), "Bioluminescence, Kirlian Photography and Medical Diagnostics", Mankind Research Unlimited (a formerly unpublished, proprietary paper).
- Miller, R.A., Webb, B. and Dickson, D. (1975), "A Holographic Concept of Reality", *Psychoenergetic Systems Journal*, vol. 1, pp. 55-62, Gordon & Breach Science Publishers Ltd, Great Britain; reprinted in the hardback book *Psychoenergetic Systems* (Stanley Krippner, editor), 1979, pp. 231-237, Gordon & Breach, New York, London, Paris; again in the journal

From Helix to Hologram: An Ode on the Human Genome

Psychedelic Monographs and Essays (1992), vol. 5, pp. 93-111 (Tom Lyttle, editor), Boynton Beach, Florida.

- Miller, R.A., Miller, I. and Webb, B. (2002), "Quantum Bioholography: A Review of the Field, 1973-2002", *JNLRMI*, vol I, no. 3. October 2002, at <http://www.emergentmind.org>.
- Miller, S.L. and Robertson, M.P. (1995), "An efficient prebiotic synthesis of cytosine and uracil", *Nature*, vol. 375, p. 772.
- Patel, A. (2000), "Quantum Algorithms and the Genetic Code", *Proceedings of the Winter Institute of Quantum Theory and Quantum Optics*, 1-13 January 2000, S.N. Bose National Centre for Basic Sciences, Calcutta, India.
- Persinger, Michael A. (1987), *Neuropsychological Bases of God Beliefs*, Praeger Publishers, New York.
- Poole, A.M., Jeffares, D.C. and Penny, D. (1998), "The path from the RNA world", *Journal of Molecular Evolution* 46(1).
- Poponin, Vladimir, "The DNA Phantom Effect: Direct Measurement of A New Field in the Vacuum Substructure" (undated paper).
- Presman (1970), *Electromagnetic Fields and Life*, Plenum, New York.
- Pribram, Karl (1971), *Languages of the Brain*, Prentice-Hall, Inc., Englewood Cliffs, New Jersey.
- Pribram, Karl (1991), *Brain and Perception: Holonomy and Structure in Figural Processing*, Lawrence Erlbaum Associates, Publishers, Hillsdale, NJ
- Pullman and Pullman (1963), *Quantum Biochemistry*, Interscience, New York.
- Rossi, E. (2000-2002), "Exploring Gene Expression in Sleep, Dreams & Hypnosis with the New DNA Microarray Technology", at

<http://home.earthlink.net/~rossi/>.

- Rossi, E., "Psyche, Soma and Gene Expression", at <http://home.earthlink.net/~rossi/>.
- Rossi, E. (2002), "The Psychobiology of Gene Expression: Neuroscience and Neurogenesis", in *Hypnosis and the Healing Arts*, W.W. Norton Professional Books, New York.
- Rossi, E. and Lippincott, B.M., "The Wave Nature of Being: Ultradian Rhythms and Mind-Body Communication", at <http://home.earthlink.net/~rossi/>.
- Schempp, W. (1992), "Quantum Holography and Neurocomputer Architectures", *Journal of Mathematical Imaging and Vision*, vol. 2, pp. 279-326.
- Schempp, W. (1993), "Bohr's Indeterminacy Principle in Quantum Holography, Self-Adaptive Neural Network Architectures, Cortical Self-organization, Molecular Computers, Magnetic Resonance Imaging and Solitonic Nanotechnology", *Nanobiology*, vol. 2, pp. 109-164.
- Shcheglov, V.A. and Gariaev, P.P. (1996), "Laser-laser interactions and phantom effects in genetic structures", *Science on the Threshold XXI Age - New Paradigms* (in Russian).
- Sidorov, L. (2002), "Control systems, transduction arrays and psi healing: an experimental basis for human potential science", *JNLRMI*, vol. I, no. 2, May 2002, at <http://www.emergentmind.org>.
- Szent-Gyorgyi (1957), *Bioenergetics*, Academic Press, New York.
- Szent-Gyorgyi (1960), *Introduction to a Submolecular Biology*, Academic Press, New York.
- Talbot, Michael (1991), *The Holographic Universe*, HarperCollins Publishers, New York.
- Wilber, Ken (1982), *The Holographic Paradigm*, Shambhalla, Boulder.

About the Authors:

- **Iona Miller** is a multimedia artist, hypnotherapist, web author and researcher who works through the Asklepia Foundation (<http://www.asklepia.org>), *Chaosophy Journal* and *JNLRMI* on the relationship between experiential journeys, physics, healing, creativity, dreams, consciousness and chaos theory. She has been collaborating with Richard Alan Miller since the mid-1970s; although they divorced in 1994, they continue to work together on leading-edge studies into consciousness, neurotheology, Qabalah, alchemy and the nature of reality. Email Iona at iona_m@yahoo.com, and visit her homepage at http://www.geocities.com/iona_m/.

- **Richard Alan Miller** started his professional career as a physicist, biophysicist and instrumentation specialist. In late 1972 he began his foray into parapsychics with experiments in Kirlian photography and developed a field theory to explain the phenomenon. He is an expert in growing and marketing botanicals, and set up his own company, Northwest Botanicals. Visit his <http://www.nwbotanicals.org> for a listing of his writings on subjects as diverse as metaphysics, parapsychology and alternative agriculture. He is currently writing a book on ESP self-induction. Richard is available for lectures and as an outside consultant. He can be contacted at OAK Publishing, Inc., 122 SW 5th Street, Grants Pass, OR 97526, USA; telephone +1 (541) 476 5588, fax +1 (541) 476 1823, email DrRam@magick.net.